

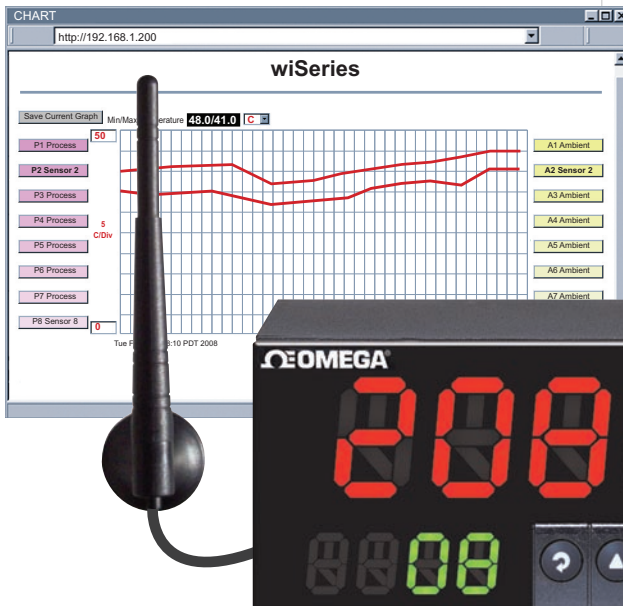

MADE IN  
**USA**

**wiSeries**



# User's Guide

Shop on line at

**omega.com**<sup>®</sup>

Ω OMEGA<sup>®</sup>

omega.com

e-mail: [info@omega.com](mailto:info@omega.com)

For Latest Product Manuals

[omegamannual.info](http://omegamannual.info)

**wi8xx-U**  
**Wireless Meter Scanner & Controller**



<b>OMEGAnet® On-Line Service</b> <a href="http://www.omega.com">www.omega.com</a>	<b>Internet e-mail</b> <a href="mailto:info@omega.com">info@omega.com</a>
--------------------------------------------------------------------------------------	------------------------------------------------------------------------------

### Servicing North America:

**USA:** One Omega Drive, P.O. Box 4047  
ISO 9001 Certified Stamford CT 06907-0047  
TEL: (203) 359-1660 FAX: (203) 359-7700  
e-mail: [info@omega.com](mailto:info@omega.com)

**Canada:** 976 Bergar  
Laval (Quebec) H7L 5A1  
TEL: (514) 856-6928 FAX: (514) 856-6886  
e-mail: [info@omega.ca](mailto:info@omega.ca)

### For immediate technical or application assistance:

**USA and Canada:** Sales Service: 1-800-826-6342 / 1-800-TC-OMEGA®  
Customer Service: 1-800-622-2378 / 1-800-622-BEST®  
Engineering Service: 1-800-872-9436 / 1-800-USA-WHEN®

**Mexico and Latin American:** TEL: (001) 203-359-7803 FAX: (001) 203-359-7807  
e-mail: [espanol@omega.com](mailto:espanol@omega.com)

### Servicing Europe:

**Benelux:** TEL: +31 20 3472121 FAX: +31 20 6434643  
Toll Free in Benelux: 0800 0993344  
e-mail: [sales@omegaeng.nl](mailto:sales@omegaeng.nl)

**Czech Republic:** Frystatska 184, 733 01 Karviná  
TEL: +420 59 6311899 FAX: +420 59 6311114  
e-mail: [info@omegashop.cz](mailto:info@omegashop.cz)

**France:** TEL: +33 1 61 37 29 00 FAX: +33 1 30 57 54 27  
Toll Free in France: 0800 466 342  
e-mail: [sales@omega.fr](mailto:sales@omega.fr)

**Germany/Austria:** Daimlerstrasse 26, D-75392 Deckenpfronn, Germany  
TEL: +49 7056 9398-0 FAX: +49 7056 9398-29  
Toll Free in Germany: 0800 639 7678  
e-mail: [info@omega.de](mailto:info@omega.de)

**United Kingdom:** One Omega Drive  
ISO 9001 Certified River Bend Technology Centre  
Northbank, Irlam Manchester M44 5BD United Kingdom  
TEL: +44 161 777 6611 FAX: +44 161 777 6622  
Toll Free in England: 0800 488 488  
e-mail: [sales@omega.co.uk](mailto:sales@omega.co.uk)

It is the policy of OMEGA to comply with all worldwide safety and EMC/EMI regulations that apply. OMEGA is constantly pursuing certification of its products to the European New Approach Directives. OMEGA will add the CE mark to every appropriate device upon certification.

The information contained in this document is believed to be correct, but OMEGA Engineering, Inc. accepts no liability for any errors it contains, and reserves the right to alter specifications without notice.

**WARNING:** These products are not designed for use in, and should not be used for, patient-connected applications.



This device is marked with the international caution symbol. It is important to read the Setup Guide before installing or commissioning this device as the guide contains important information relating to safety and EMC.

# TABLE OF CONTENTS

<b>Part 1 Introduction</b>	1
1.1 Safety Considerations	1
1.2 Before You Begin	2
1.3 Description	3
<b>Part 2 Hardware</b>	5
2.1 Physical Characteristics and Mounting	5
2.1.1 Front Panel	5
2.1.2 Rear Panel	6
2.1.3 Dimensions	7
2.1.4 Assembly and Mounting	8
2.1.4.1 Panel Mounting Instruction	8
2.1.4.2 Antenna Mounting Instruction	9
2.1.4.3 Disassembly Instruction	10
2.1.5 Electrical Installation	11
2.1.5.1 Power Connections	11
2.1.5.2 Wiring Outputs	12
2.1.5.3 Jumper Settings for Display Color Setup	14
2.1.5.4 DIP Switches	15
2.2 Network Communications	16
2.2.1 10Base-T RJ45 Pinout	16
2.2.2 10Base-T Crossover Wiring	16
<b>Part 3 Network Configuration</b>	17
3.1 Ethernet (MAC) Address	17
3.2 Network Protocols	17
3.3 DHCP	17
3.4 DNS	18
3.5 IP Address	19
3.5.1 Default IP Address	19
3.5.2 Changing TCP/IP Properties on your Computer	20
<b>Part 4 Network Operations</b>	21
4.0 Testing the Connection	21
4.1 iConnect Software	22
4.2 Setting a New IP Address over the Network	24
4.3 Meter's Configurations and Operations	25
4.3.1 Power Up Meter	26
4.3.2 Get Readings from the End Device	27
4.3.3 Java Runtime Environment Setup	29
4.3.3.1 Java Runtime Environment 1.5 (5.0) Setup Instructions	29
4.3.3.2 Java Runtime Environment 1.4 Setup Instructions	30
4.3.3.3 Browser Proxy Selection	31
4.3.4 Java Policy	32
4.3.5 Chart	34
4.3.6 Controller Setup	36

4.3.7	Setup	.38
4.3.7.1	Input	.38
4.3.7.2	Setpoints & On/Off Control	.39
4.3.7.3	Alarms 1 & 2	.41
4.3.7.4	Analog Output Retransmission	.43
4.3.7.5	Display	.44
4.3.7.5.1	Display Color Examples	.46
4.3.7.6	Passcode ID	.48
4.3.8	Network Setup	.49
4.3.9	End Device Setup	.51
4.3.9.1	End Device Parameters	.53
4.3.10	Access Control	.55
4.4	Telnet Setup	.57
4.5	HTTPget Program	.58
4.5.1	HTTPget using Port 2000	.58
4.5.2	HTTPget and ARP to Setup Device IP Address	.59
4.6	ARP Protocol	.60
4.7	iLog Software	.61
4.8	Mail Notifier Software	.63
4.8.1	Installation	.63
4.8.2	Program Options Setup and Configuration	.64
4.8.3	Device Settings and Configuration	.65
<b>Part 5</b>	<b>Environment/Operating Conditions</b>	<b>.67</b>
5.1	General Deployment Guidelines	.67
5.2	With Line-of-Sight	.69
5.3	Without Line-of-Sight	.70
5.4	Casing and Closure Around the Antenna	.70
<b>Part 6</b>	<b>Specifications</b>	<b>.71</b>
<b>Part 7</b>	<b>Factory Preset Values</b>	<b>.74</b>
Appendix A	Glossary	.78
Appendix B	IP Address	.79
Appendix C	IP Netmask	.80
Appendix D	ASCII Chart	.81
Appendix E	iLog Error Messages	.83
Appendix F	Warning and Regulatory Information	.83

## LIST OF FIGURES:

Figure 1.1	Temperature Wireless Monitor and Control System on the Ethernet Network	.4
Figure 2.1	Front Panel Display	.5

Figure 2.2 Rear Panel Power and Output Connections .....6

Figure 2.3 Mounting Dimensions .....7

Figure 2.4 Panel Mounting .....8

Figure 2.5 Antenna Mounting .....9

Figure 2.6 Accessing the Main Board Assembly .....10

Figure 2.7 Main Power Connections .....11

Figure 2.8a Mechanical Relay and SSR Output Wiring Hookup .....12

Figure 2.8b Pulse and Analog Output Wiring Hookup .....12

Figure 2.9 Typical Applications .....13

Figure 2.10 Location of S1 Jumper .....14

Figure 2.11 Location of DIP Switches .....15

Figure 2.12 RJ45 Pinout .....16

Figure 2.13 10Base-T Crossover Cable Wiring .....16

Figure 3.1 Label Detail .....17

Figure 3.2 4 Position DIP Switch .....18

Figure 3.3 Network Connections .....20

Figure 3.4 Network Connections .....20

Figure 4.1 Pinging the Meter from MS-DOS Prompt .....21

Figure 4.2 Assigning an IP Address using iConnect .....22

Figure 4.3 Accessing the Wireless System for Configuration .....23

Figure 4.4 Access Control .....24

Figure 4.5 Wireless System Home Page Menu .....25

Figure 4.6 LOGIN and ADMINISTRATOR Passwords .....26

Figure 4.7 Readings .....27

Figure 4.8 Comma Separated Value Format .....28

Figure 4.9 Java 1.5.x.x Screen Shots .....29

Figure 4.10 Java 1.4 Screen Shots .....30

Figure 4.11 Java Policy .....32

Figure 4.12 Java Policy .....33

Figure 4.13 Chart .....34

Figure 4.14 Controller Setup .....36

Figure 4.15 Input .....38

Figure 4.16 Setpoints & On/Off Control .....40

Figure 4.17 Alarms 1 & 2 .....42

Figure 4.18 Analog Output Retransmission .....43

Figure 4.19a Display Menu .....44

Figure 4.19b Display Menu (if Analog Output Option) .....45

Figure 4.20 ID Code .....48

Figure 4.21 Network Setup .....49

Figure 4.22 End Device Setup .....51

Figure 4.23 End Device Parameters .....53

Figure 4.24 Remote End Char .....54

Figure 4.25 Access Control .....55

Figure 4.26 HTTPget Example of Polling End Device .....59

Figure 4.27	ARP Commands and Responses	60
Figure 4.28	iLog Software Logging Data for End Device	61
Figure 4.29	Mail Notifier Main Window	63
Figure 4.30	Mail Notifier Profile Setup	64
Figure 4.31	Mail Notifier Device Settings	66
Figure 5.1	Operation in Buildings	68
Figure 5.2	Fresnel Zone	69
Figure 5.3	Materials in Buildings	70

**LIST OF TABLES:**

Table 2.1	Front Panel Enunciators	5
Table 2.2	Rear Panel Connector	6
Table 2.3	Fuse Requirements (See Specifications)	11
Table 4.1	List of Commands	59
Table 4.2	Connector/Transmitter Types	59
Table 4.3	iLog Excel Applications	62
Table 4.4	Mail Notifier Commands	65
Table 7.1	Factory Presets	74

# PART 1 INTRODUCTION

## 1.1 Safety Considerations



This device is marked with the international caution symbol. It is important to read this manual before installing or commissioning this device as it contains important information relating to Safety and EMC (Electromagnetic Compatibility).

This instrument is a panel mount device protected in accordance with EN 61010-1:2001, electrical safety requirements for electrical equipment for measurement, control and laboratory. Installation of this instrument should be done by qualified personnel. In order to ensure safe operation, the following instructions should be followed.



This instrument has no power-on switch. An external switch or circuit-breaker shall be included in the building installation as a disconnecting device. It shall be marked to indicate this function, and it shall be in close proximity to the equipment within easy reach of the operator. The switch or circuit-breaker shall meet the relevant requirements of IEC 947-1 and IEC 947-3 (International Electrotechnical Commission). The switch shall not be incorporated in the main supply cord.



Furthermore, to provide protection against excessive energy being drawn from the main supply in case of a fault in the equipment, an overcurrent protection device shall be installed.



- Do not exceed voltage rating on the label located on the top of the instrument housing.
- Always disconnect power before changing signal and power connections.
- Do not use this instrument on a work bench without its case for safety reasons.
- Do not operate this instrument in flammable or explosive atmospheres.
- Do not expose this instrument to rain or moisture.
- Unit mounting should allow for adequate ventilation to ensure instrument does not exceed operating temperature rating.
- Use electrical wires with adequate size to handle mechanical strain and power requirements. Install without exposing bare wire outside the connector to minimize electrical shock hazards.

## EMC Considerations

- Whenever EMC is an issue, always use shielded cables.
- Never run signal and power wires in the same conduit.
- Use signal wire connections with twisted-pair cables.
- Install Ferrite Bead(s) on signal wires close to the instrument if EMC problems persist.



**Failure to follow all instructions and warnings may result in injury!**



This is a Class A ITE product. In a domestic environment this product may cause radio interference in which case the user may be required to take adequate measures.

## 1.2 Before You Begin

### Inspecting Your Shipment:

Remove the packing slip and verify that you have received everything listed. Inspect the container and equipment for signs of damage as soon as you receive the shipment. Note any evidence of rough handling in transit. Immediately report any damage to the shipping agent. The carrier will not honor damage claims unless all shipping material is saved for inspection. After examining and removing the contents, save the packing material and carton in the event reshipment is necessary.

### Customer Service:

If you need assistance, please call the nearest Customer Service Department, listed in this manual.

### Manuals, Software:

The latest Operation Manual as well as free configuration software (iConnect) are **available from the website listed on the cover pages of this manual, or on the CD-ROM enclosed with your shipment.**

## NOTES, WARNINGS and CAUTIONS

Information that is especially important to note is identified by following labels:



**NOTE:** Provides you with information that is important to successfully setup and use the Programmable Digital Meter.



**CAUTION or WARNING:** Tells you about the risk of electrical shock.



**CAUTION, WARNING or IMPORTANT:** Tells you of circumstances or practices that can effect the instrument's functionality and must refer to accompanying documents.



**TIP:** Provides you helpful hints.

## 1.3 Description

The **wi®Series** wireless monitoring and control system features meters compatible with a large and growing number of wireless sensors: **UWTC “Universal Wireless Thermocouple”** Type J, K, T, E, R, S, B, N, and C, **UWRD “Universal Wireless RTD”**, and **UWIR “Universal Wireless Infrared Temperature Sensor”**. For more information about the UWTC, UWRD, and UWIR, refer to the separate manual for these products.



### 1.3 Description (continued)

The wireless sensors transmit up to four hundred feet 400' (approx. 120 meters--without obstructions or interference) to a wiSeries meter connected directly to an Ethernet network and the Internet. The wireless system complies with IEEE 802.15.4 operating at 2.4 GHz. The wiSeries Meter Scanner & Controller can monitor up to eight (8) wireless sensors.

The Meter also provides error detection mechanism for inactive communication and diagnostic information including signal strength and data transmission success rate to help troubleshooting potential wireless system installation issues.

The Meter connects directly to an Ethernet network and the Internet and features award-winning embedded Web Server. It is easily configured and monitored with a Web browser over the Ethernet network or the Internet.

**CONTROL, MONITOR, AND ALARM:** The Meter comes standard with dual outputs of either Form C relays, SSR's (solid state relays) or dc Pulses that can be used for ON/OFF control functions or alarms.

The meter can monitor alarm conditions for any or all of the wireless sensors. For example, the meter can be set up to trip an alarm if any one of the sensors indicated that it was above or below a pre-set alarm point.

Analog output is fully scalable and may be configured as an ON/OFF controller or re-transmission to follow your readings.

**MONITOR AND CONTROL LOCALLY AND OVER THE INTERNET:** The wiSeries wireless monitoring and control system provides local monitoring and control, along with remote Web-based monitoring of temperature from thermocouples, RTD's, and infrared temperature sensors.

The wiSeries system let's you monitor and record temperature over an Ethernet network or the Internet without any special software--just your Web Browser.

**ETHERNET:** The wiSeries meter-controller-scanner is an independent node on the network sending and receiving data in standard TCP/IP packets. It is easily configured from a Web Browser and can be password protected. From within an Ethernet LAN or over the Internet, the user simply types the IP address (such as 192.168.1.200) or an easy to remember name (such as "Oven5" or "Fixture") and the wiSeries meter serves a Web Page with the current readings.

**EMAIL ALARM:** The wiSeries meter can trigger an alarm if variables go above or below a Setpoint that you determine. Your alarm can be sent by email to a single user or to a group distribution list, including text messages to cell phones and PDA's. The "Mail Notifier" software is a free and easy program for this application.

**CHARTS AND GRAPHS:** The wiSeries system serves Active Web Pages to display real time readings and charts of temperature. You can also log data in standard data formats for use in a spreadsheet or data acquisition program such as Excel or Visual Basic. We offer a free and easy to use program iLog for logging data to Excel.

The virtual chart viewed on the web page is a JAVA™ Applet that records a chart over the LAN or Internet in real time. With the wiSeries system there is no need to invest time and money learning a proprietary software program to log or chart the data. Chart scales are fully adjustable on the fly. For example, the chart can display one minute, one hour, one day, one week, one month or one year. Temperature can be charted across the full span or within any narrow range such as (20 to 30°C).

### 1.3 Description (continued)

**DATALOGGING:** The OPC Server software makes it easy to integrate the wiSeries wireless sensor system with many popular Data Acquisition and Automation programs offered by NEWPORT, OMEGA, Wonderware, iConics, Intellution, Rockwell Automation, and National Instruments, among others.

**PROGRAMMABLE COLOR DISPLAY:** The wiSeries features patented programmable color displays. The display can be programmed to change color at any Setpoint or Alarm point. For example, the meter can be programmed to display the process value in **GREEN** during warm-up, switching to **AMBER** to signal the normal operating range, and in **RED** to signal an alarm condition. The changes in color are quickly seen from a distance, and machine operators can intuitively react to changing conditions. The colors can be programmed to change back when the value drops back below the alarm point or to "latch" on until being reset by the operator.

The meter can also be programmed to display only one unchanging color: **GREEN**, **AMBER**, or **RED**. This is a useful way to let an operator identify, at a glance, temperature values in three separate locations, or to display three different measurements.

The following example **Figure 1.1** illustrates how you can hookup the Temperature Wireless System to your network:

The wireless system consists of a single Meter and one or more End Devices / Transmitters. The End Devices will send data periodically to the Meter where it serves as a gateway between the users and the End Devices. The users can access the data through the Meter's Web Server and provided data acquisition software.

A standard web browser can be used to monitor and chart temperature. The browser can also be used to configure the meter's IP address, passwords for access and overall configuration parameters.

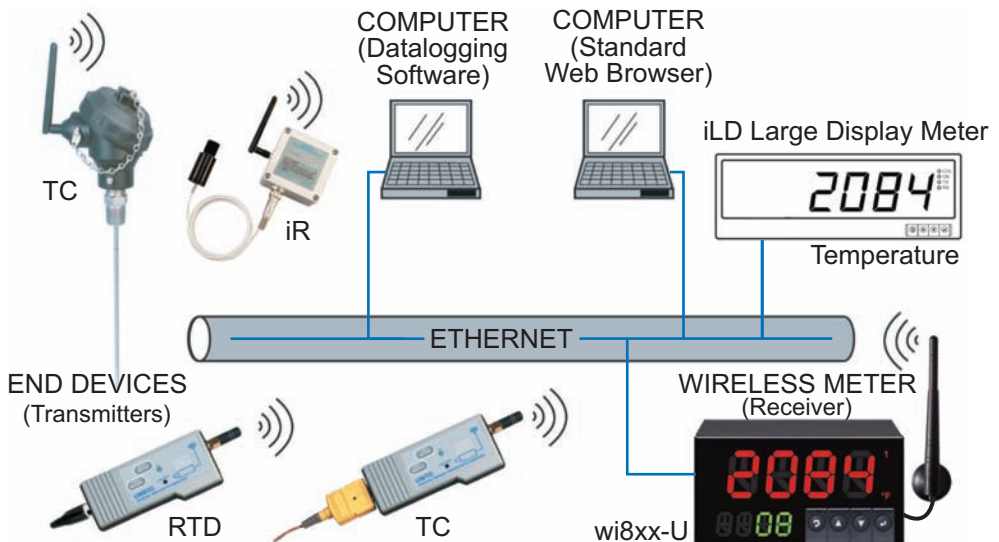

**Figure 1.1 Temperature Wireless Monitor and Control System on the Ethernet Network**

## PART 2 HARDWARE







### 2.1 Physical Characteristics and Mounting

#### 2.1.1 Front Panel



**Figure 2.1 Front Panel Display**

**Table 2.1 Front Panel Enunciators**

1	Output 1 / Setpoint 1 / Alarm 1 indicator
2	Output 2 / Setpoint 2 / Alarm 2 indicator
°C	°C unit indicator for Temperature
°F	°F unit indicator for Temperature
	Changes display to Configuration Mode and advances through menu items. Make sure to press  twice (Stand-by) followed by pressing  (stop communication) before entering the Configuration mode.
	Used in Configuration Mode to change values. In Run Mode, it's used to lock the display to the next sensor reading.
	Used in Configuration Mode to change values. It's also used to resume scrolling sensors.
	Accesses submenus in Configuration Mode and stores selected values

**Note**

For complete Front Panel Pushbutton procedures, refer to the Supplemental Guide.



### 2.1.3 Dimensions

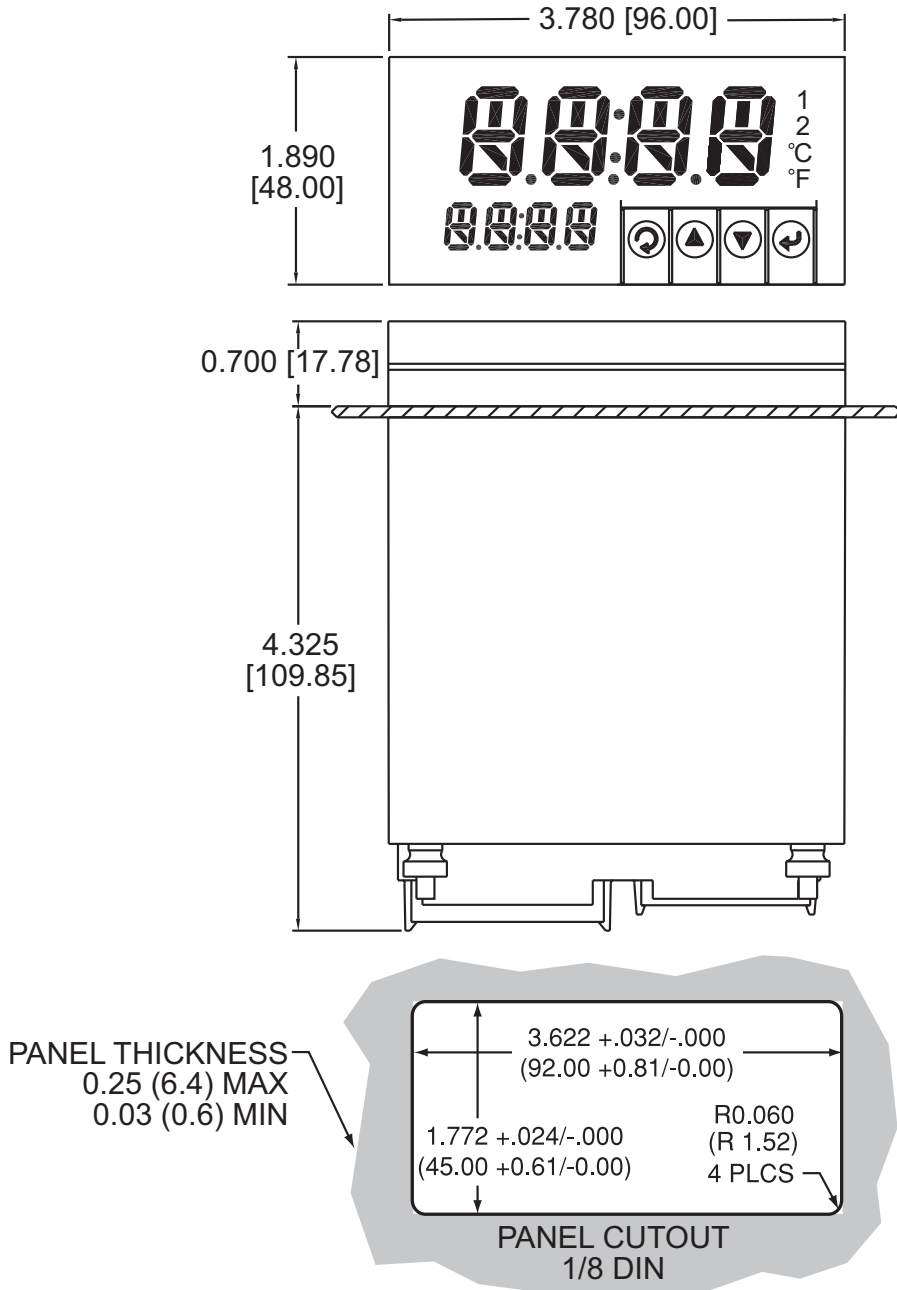
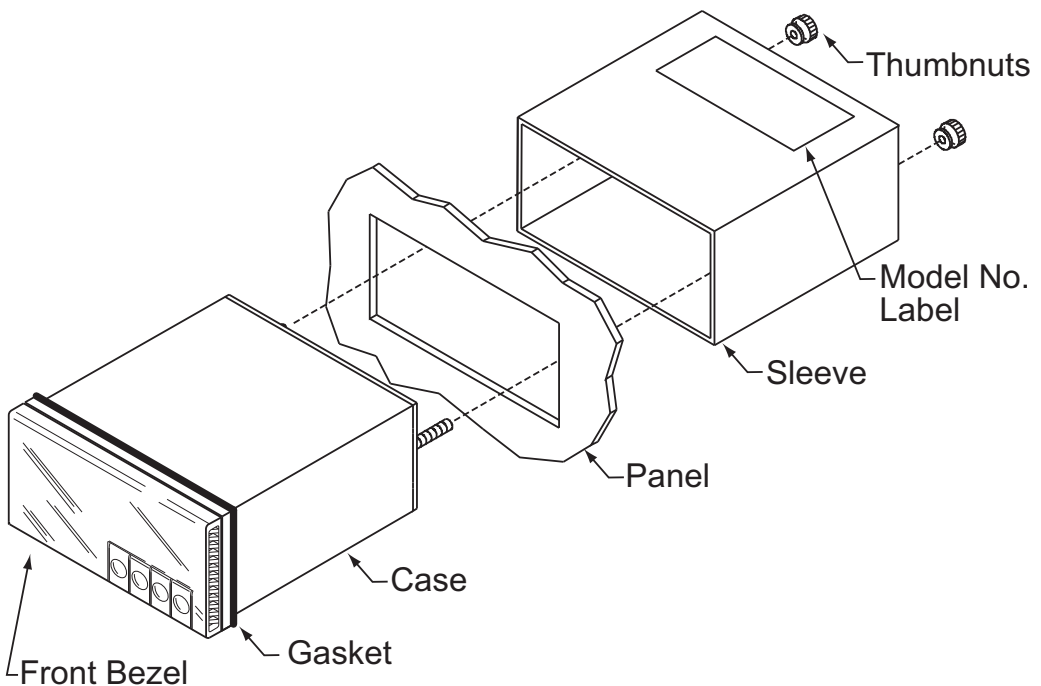

Figure 2.3 Mounting Dimensions

## 2.1.4 Assembly and Mounting

### 2.1.4.1 Panel Mounting Instruction

1. Using the dimensions from the panel cutout in **Figure 2.3**, cut an opening in the panel.
2. Remove sleeve from the rear of the case by removing thumbnuts.
3. Insert the case into the opening from the front of the panel, so the gasket seals between the bezel and the front of the panel.
4. Slip the sleeve over the rear of the case.
5. Tighten the thumbnuts to hold the unit firmly in the panel.



**Figure 2.4 Panel Mounting**

### 2.1.4.2 Antenna Mounting Instruction

For best reception: connect the antenna directly to the rear of the meter, if the meter is not installed in a metal panel or enclosure.

If the rear of the meter is behind a metal panel or in a cabinet, use a coaxial cable to position the antenna outside of the enclosure in the open air.

Use the shortest cable that can reach a suitable location. The antenna on this Meter and any End Devices should be installed in a vertical position, pointing towards the sky.

**Note**

Metallic structure should be kept at least 0.8" (2 cm), although 2.4" (6 cm) is recommended away from the antenna.

Any casing that encloses the antenna should be plastic. In addition, it is also wise to avoid plastic case with dark fillers or colorants.

Refer to **Section 5** for more Environmental / Operating Conditions.

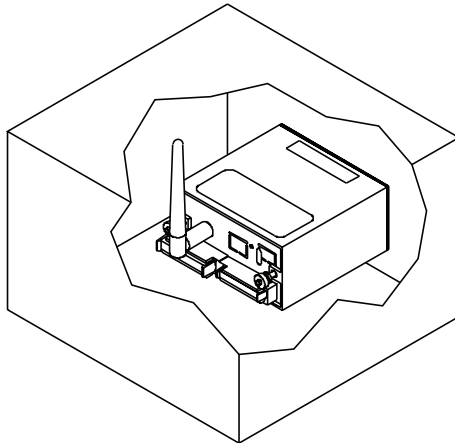

METER MOUNTED  
IN NON-METALIC  
ENCLOSURE.

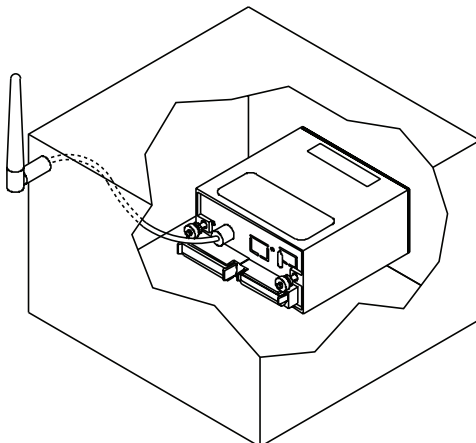

METER MOUNTED  
IN A METALIC  
ENCLOSURE.

**Figure 2.5 Antenna Mounting**

### 2.1.4.3 Disassembly Instruction

If necessary, the board assembly may be removed from the front of the case housing.



**Warning: Disconnect ac power from the unit before proceeding.**

1. Remove the board assembly from the case by pulling at the sides of the bezel.
2. The bezel, along with the board assembly will unlatch from the case housing.

**Note**

- Depending on the size of your Ethernet connector, you may need to disconnect it from the RJ45 jack on the rear of the meter.
- Depending on the length of your antenna cable, you may need to disconnect it from the rear of the meter.

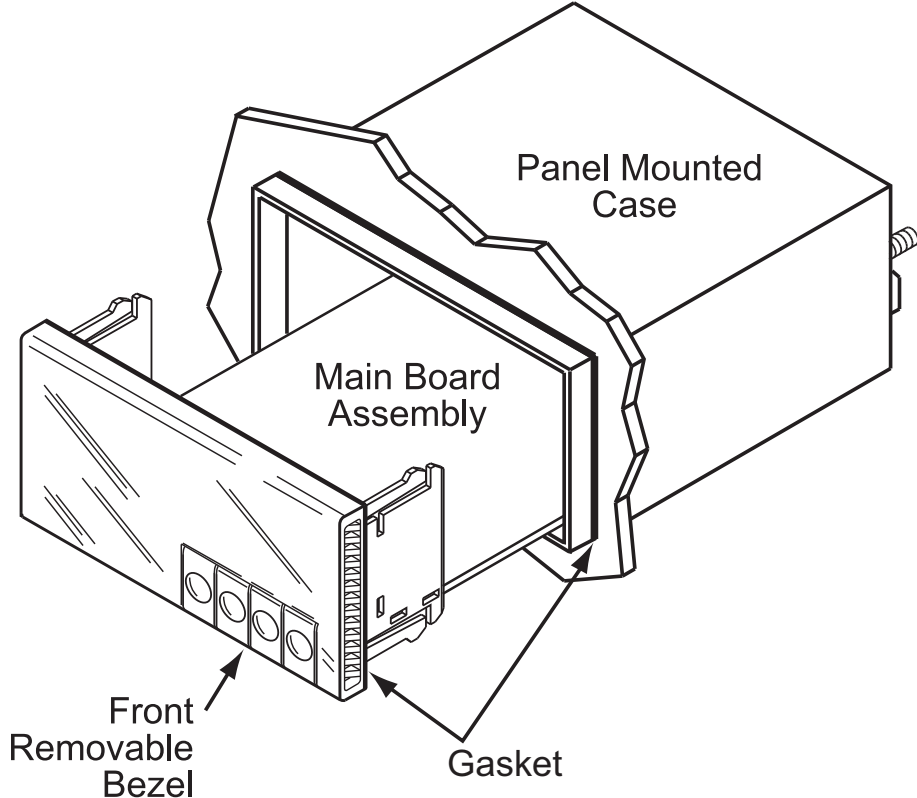

**Figure 2.6 Accessing the Main Board Assembly**



## 2.1.5 Electrical Installation

### 2.1.5.1 Power Connections



**Warning:** Do not connect ac power to your meter until you have completed all output connections. This meter must only be installed by a specially trained electrician with corresponding qualifications. Failure to follow all instructions and warnings may result in injury!

Connect the main power connections as shown below.

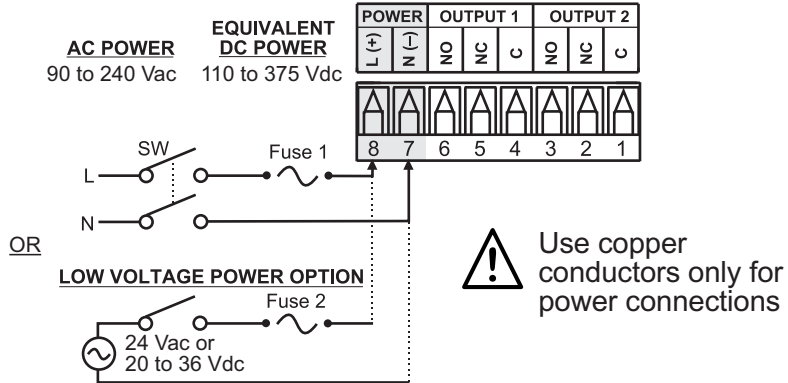

**Figure 2.7 Main Power Connections**

**Table 2.3 Fuse Requirement (See Specifications Section)**

FUSE	Connector	Output Type	For 115Vac	For 230Vac	DC
FUSE 1	Power	N/A	100 mA(T)	100 mA(T)	100 mA(T)
FUSE 2	Power	N/A	N/A	N/A	400 mA(T)



For the low voltage power option, in order to maintain the same degree of protection as the standard high voltage input power units (90 - 240 Vac), always use a Safety Agency Approved DC or AC source with the same Overvoltage Category and pollution degree as the standard AC unit (90 - 240 Vac).



The Safety European Standard EN61010-1 for measurement, control, and laboratory equipment requires that fuses must be specified based on IEC127. This standard specifies for a Time-lag fuse, the letter code "T". The above recommended fuses are of the type IEC127-2-sheet III. Be aware that there are significant differences between the requirements listed in the UL 248-14/CSA 248.14 and the IEC 127 fuse standards. As a result, no single fuse can carry all approval listings. A 1.0 Amp IEC fuse is approximately equivalent to a 1.4 Amp UL/CSA fuse. It is advised to consult the manufacturer's data sheets for a cross-reference.

### 2.1.5.2 Wiring Outputs

This meter has two factory installed outputs. The SPDT Mechanical Relay, SPST Solid State Relay, Pulse and Analog Output Connection are shown below.

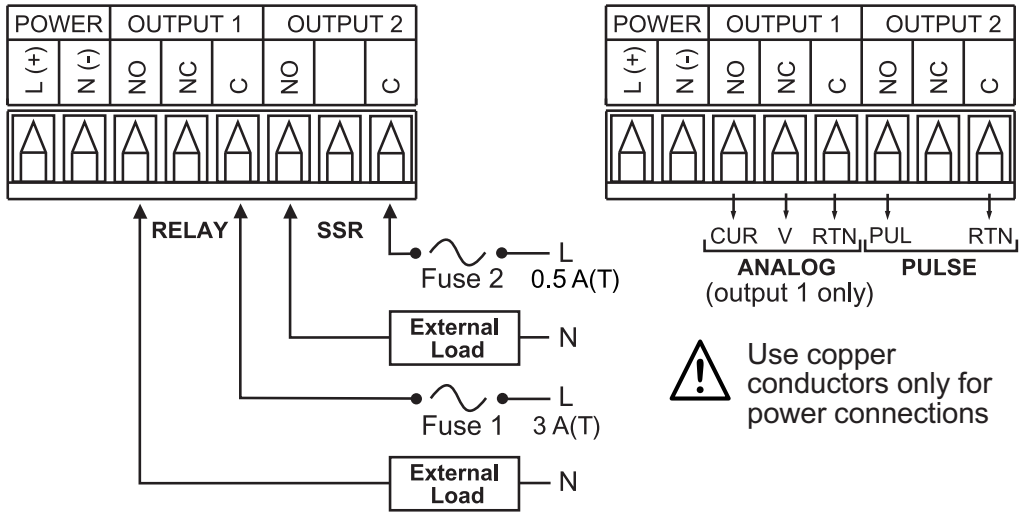

Figure 2.8

a) Mechanical Relay and SSR Outputs Wiring Hookup

b) Pulse and Analog Outputs Wiring Hookup

## 2.1.5.2 Wiring Outputs (continued)

dc CONTROLLED SSR USED WITH TEMPERATURE CONTROLLER WITH dc VOLTAGE SSR DRIVER OUTPUT

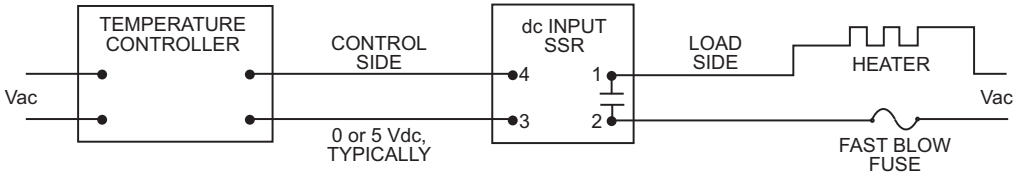

ac CONTROLLED SSR USED WITH TEMPERATURE CONTROLLER WITH MECHANICAL RELAY OUTPUT

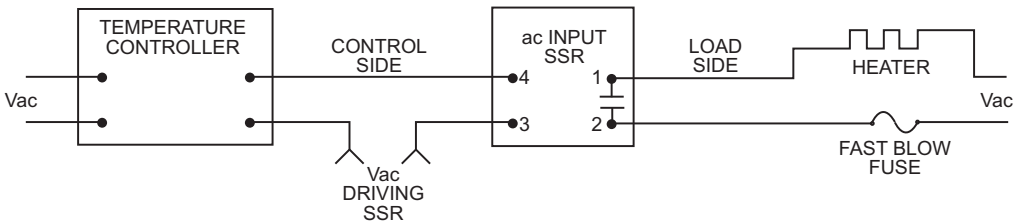

ac CONTROLLED SSR USED WITH TEMPERATURE CONTROLLER WITH TRIAC OUTPUT

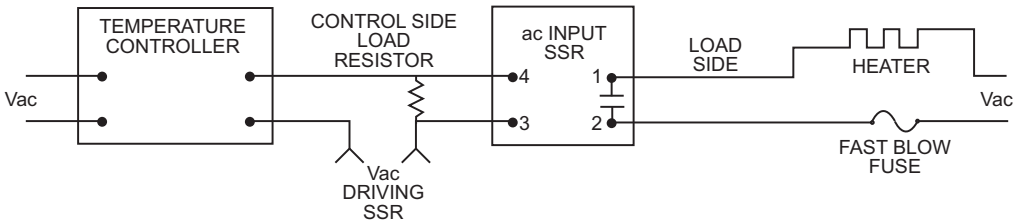

**Figure 2.9 Typical Applications**

### 2.1.5.3 Jumper Settings for Display Color Setup

To change the color of the lower display follow the instructions below:

1. The unit should be removed from the panel and opened.

Refer to **Section 2.1.4.3** for assembly and disassembly instructions.

2. Locate S1 jumper, on the back side of the display board. Select the position for your color choice of Red, Green or Amber.

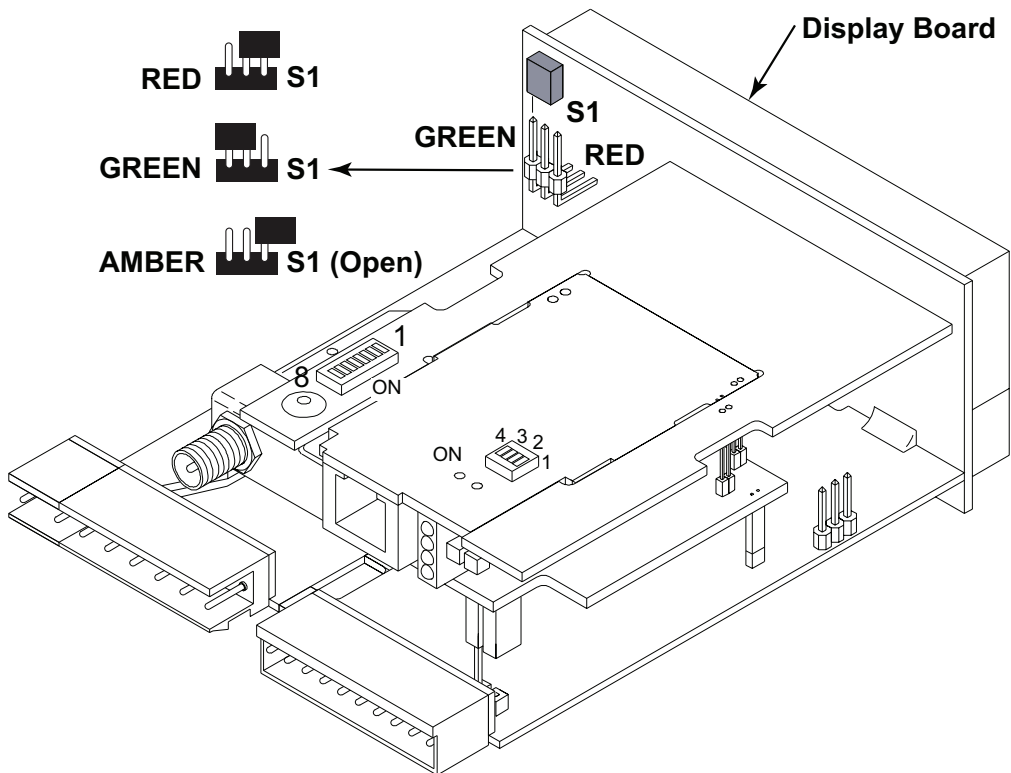

**Figure 2.10 Location of S1 Jumper**



To change the color of the upper Display, see **Section 4.3.7.5**.

## 2.1.5.4 Dip Switches

To change the DIP switches, follow the instructions below:

1. The unit should be removed from the panel and opened.  
Refer to **Section 2.1.4.3** for assembly and disassembly instructions.
2. Locate the 4 and 8 position DIP switches, on the top board.



The Meter is shipped with all DIP switches in "OFF" position  
To set the Wireless and Ethernet settings to Factory Default, Refer to **Section 7**.

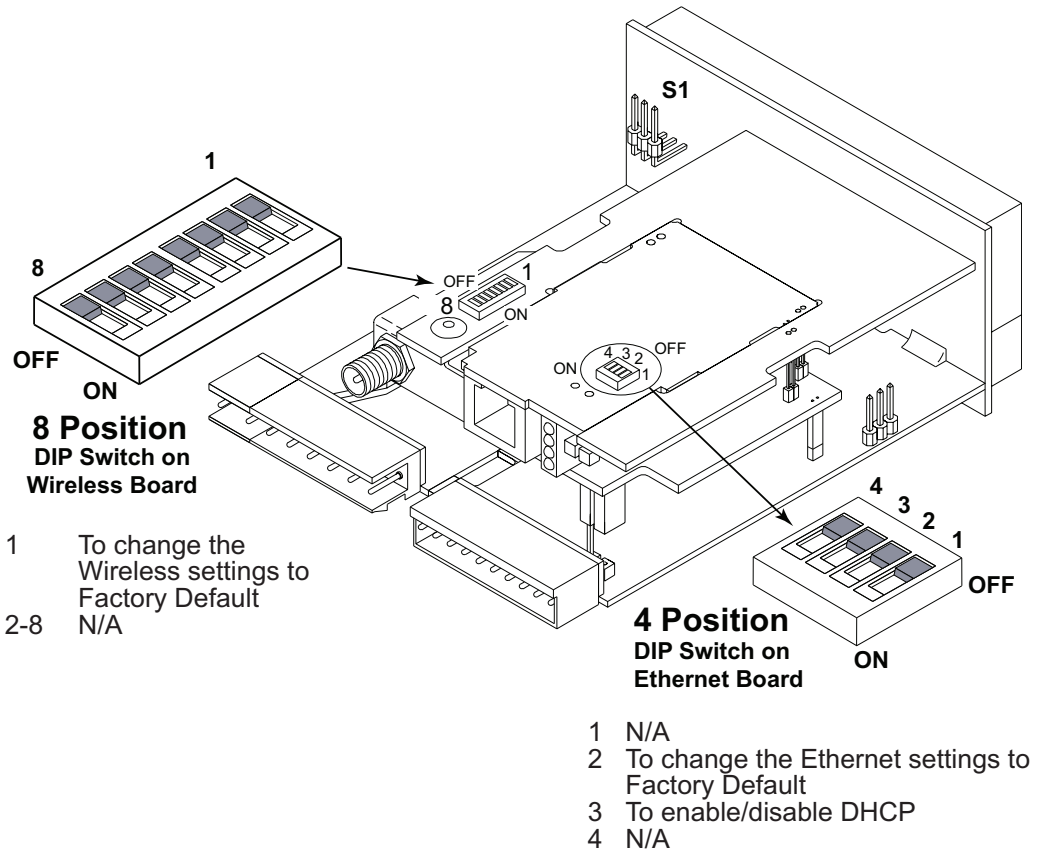

**Figure 2.11 Location of DIP Switches**

## 2.2 Network Communication Interfaces

### 2.2.1 10Base-T RJ-45 Pinout

The 10BASE-T Ethernet network (RJ-45) system is used in the Meter for network connectivity. The 10 Mbps twisted-pair Ethernet system operates over two pairs of wires. One pair is used for receiving data signals and the other pair is used for transmitting data signals. This means that four pins of the eight-pin connector are used.

#### ETHERNET

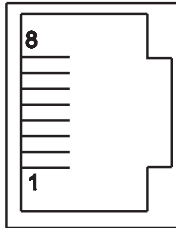

Pin	Name	Description
1	+Tx	+ Transmit Data
2	-Tx	- Transmit Data
3	+RX	+ Receive Data
4	N/C	Not Connected
5	N/C	Not Connected
6	-Rx	- Receive Data
7	N/C	Not Connected
8	N/C	Not Connected

Figure 2.12 RJ45 Pinout

### 2.2.2 10Base-T Crossover Wiring

When connecting the iServer directly to the computer, the transmit data pins of the computer should be wired to the receive data pins of the Meter, and vice versa. The 10Base-T crossover cable with pin connection assignments are shown below.

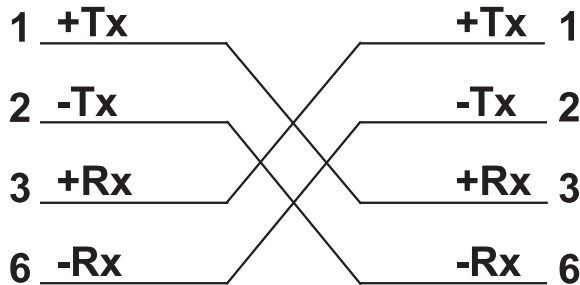

Figure 2.13 10Base-T Crossover Cable Wiring



Use straight through cable for connecting the Meter to an Ethernet hub. The ports on the hub are already crossed.

## PART 3

# NETWORK CONFIGURATION

### 3.1 Ethernet (MAC) Address

MAC (Media Access Control) address is your computer's unique hardware number. When you're connected to the LAN from your computer, a correspondence table relates your IP address to your computer's physical (MAC) address. The MAC address can be found on the label of your meter (see **Figure 2.4** and **3.1**) and contains 6 bytes (12 characters) of hexadecimal numbers XX:XX:XX:XX:XX:XX For Example: 0A:0C:3D:0B:0A:0B

Remove the small label with the **default IP** address and there will be room to put your IP address.

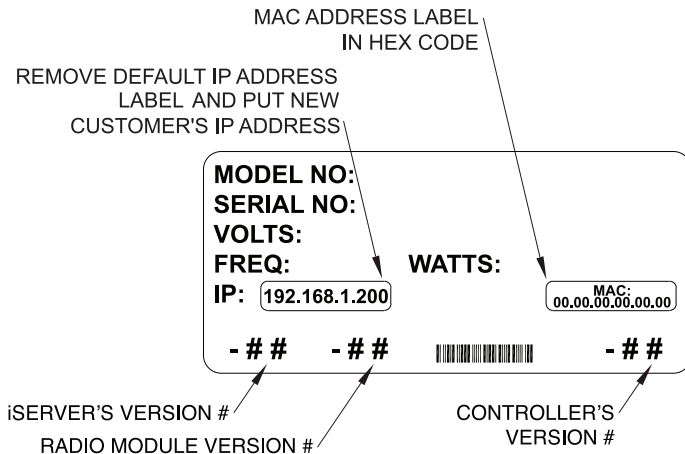

**Figure 3.1 Label Detail**

### 3.2 Network Protocols

The Meter can be connected to the network using standard TCP/IP protocols. It also supports ARP, HTTP (Web Server), DHCP, DNS and Telnet protocols.

### 3.3 DHCP

DHCP, Dynamic Host Configuration Protocol enables individual computers or devices to extract their IP configurations from a server (DHCP server).

If the DHCP is enabled on your Meter, as soon as the Meter is connected to the network, there is an exchange of information between DHCP server and the Meter. During this process the IP address, the Gateway address, and the Subnet Mask will be assigned to the Meter by the DHCP server. Note that the DHCP server must be configured correctly to do such assignment.

### 3.3 DHCP (continued)

The Meter is shipped with DHCP disabled (factory default).

If fixed or static IP address is desired, the DHCP must be disabled.

The DHCP can be enabled by setting the DIP switch # 3 to the "ON" position

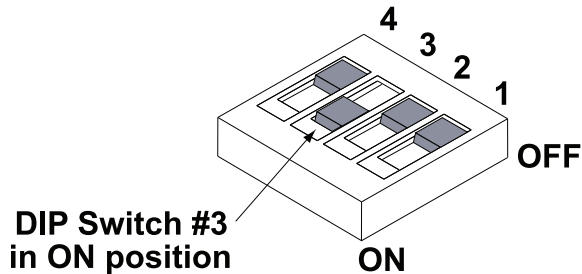

Figure 3.2 4 Position DIP Switch



Setting the Meter's IP address to 0.0.0.0 will also enable DHCP.

### 3.4 DNS

DNS, Domain Name System enables individual computers and devices to be recognized over a network based on a specific name instead of an IP address.

For example, instead of having to use **http://192.168.1.200** (IP address), you would use only **http://wis03ec** or any eight character name stored as Host Name under "Access Control" page from the Wireless System Home Page.

The default DNS name for the Meter is "**wis**" followed by the **last four digits** of the MAC address of that particular Meter.



1. It is very important to communicate with the network administrator in order to understand the DHCP and its existing configurations on the host server, before enabling the DHCP on the Meter.
2. The Meters are shipped with a default static IP address of **192.168.1.200** and Subnet Mask of **255.255.255.0**.
3. On Windows servers where the DHCP and DNS are separate functions it is very important to configure the DHCP server to communicate with the DNS in order for the iServer's Host Name to correctly respond. If you cannot access the iServer using its Host Name, please contact your network administrator to make sure the DHCP and DNS servers are linked together.



## 3.5 IP Address

Every active device connected to the TCP/IP network must have a unique IP address. This IP address is used to establish a connection to the Meter. Every computer using TCP/IP should have a unique 32-bit address which is divided into two portions, the network ID and the host ID. For instance, every computer on the same network uses the same network ID. At the same time, all of them have a different host ID. For more details about the IP address see **Appendix B**.

### 3.5.1 Default IP Address

The Meter is shipped with a default IP address of **192.168.1.200** and Subnet Mask of **255.255.255.0**. If you are going to use a Web browser or Telnet program to access the Meter using its default IP address, make sure that the PC from which you're establishing the connection has an IP address that is in the same range as the Meter's IP address (**192.168.1.x**, where **x** can be any number from 1 to 254). See **Section 3.5.2**.

 **Note** Your PC's IP address cannot be the same as the Meter's IP address.

You also need to make sure that your PC's Subnet Mask is **255.255.255.0**. This is a good way to access the Meter over the network and make any configuration changes needed. If **192.168.1.200** is already in use on your network, use an Ethernet crossover cable between your computer and the Meter to change the IP address or any other settings within the Meter.

### 3.5.2 Changing TCP/IP Properties on Your Computer

Go to your computer's **Control Panel** then **Network Connections**. Pick the network with the proper Ethernet card. Right click and choose **Properties**

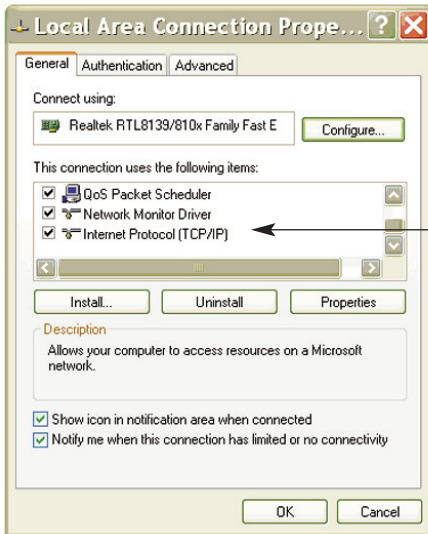

Look for **Internet Protocol**, click on it and press **Properties**

**Figure 3.3 Network Connections**

Setup the IP address (in this case, 192.168.1.1) as shown below and press OK

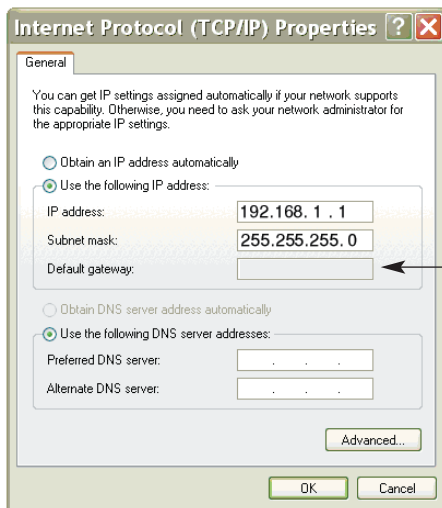

You can access the Meter's Web Server via any internet browser using IP address of **192.168.1.200**.

Once you log into the Meter's Web Server, you will be able to change its IP configuration according to **Section 4.2**.

**Note** After you configure the Meter's IP configurations, you should go back and set your PC's previous IP settings.

**Figure 3.4 Network Connections**

## PART 4 NETWORK OPERATIONS

This Meter can be used and configured in several ways, depending on user's preference and network setup. It can be configured using a Web browser, like Internet Explorer. It can also be configured using the iConnect Configuration Software.

If DHCP and DNS servers are configured to exchange information, the connection will be very simple. All you need to do is to enable DHCP on the Meter (see **Section 3.3**) and use a straight through network cable to connect the Meter to an Ethernet hub or switch and power it up. Now, you can use the Meter's default Host (Domain) Name, which is **wisxxxx** (where xxxx are the last four characters of its MAC address) to access the Meter's Web Server.

If DHCP is not the preferred method, you can configure your PC's network connection with an IP address of **192.168.1.x** that is in the same range as the Meter's default IP address (**192.168.1.200**) and connect to the Meter using a cross-over network cable between your PC's network port and the Meter. After you're done with configuring the Meter, you can always set your PC back to its original settings. See **Section 3.5.2** for more details.

On your computer, from the MS-DOS Prompt window type "**ping 192.168.1.200**" and press Enter. If DHCP and DNS servers are used type "**ping wisxxxx**", where xxxx are the last four digits of the Meter's MAC address, located on the meter. You should get a reply as shown in **Figure 4.1**.

**Note** You can use the host name (**wisxxxx**) instead of the IP address only if your DHCP server is configured to communicate with your DNS. Please consult with your IT department for details.

### 4.0 Testing the Connection

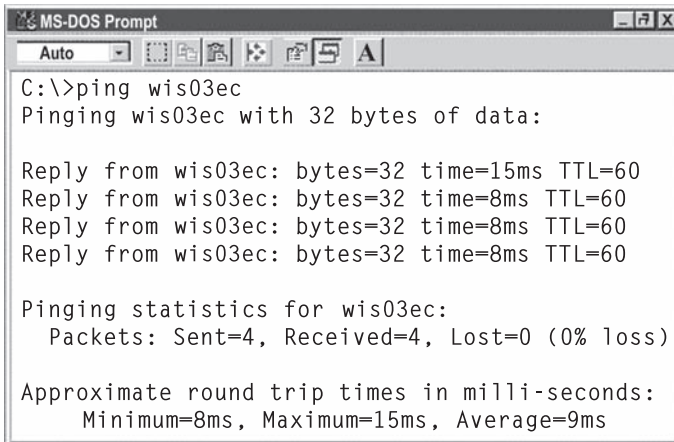

```
MS-DOS Prompt
Auto
C:\>ping wis03ec
Pinging wis03ec with 32 bytes of data:

Reply from wis03ec: bytes=32 time=15ms TTL=60
Reply from wis03ec: bytes=32 time=8ms TTL=60
Reply from wis03ec: bytes=32 time=8ms TTL=60
Reply from wis03ec: bytes=32 time=8ms TTL=60

Pinging statistics for wis03ec:
    Packets: Sent=4, Received=4, Lost=0 (0% loss)

Approximate round trip times in milli-seconds:
    Minimum=8ms, Maximum=15ms, Average=9ms
```

**Figure 4.1** Pinging the Meter from MS-DOS Prompt

This proves that the connection is proper and you can get into configuration or run mode using the Telnet or Web browser.

## 4.1 iConnect Software

The Meter may also be assigned an IP Address by using the iConnect software.

- a) Download the iConnect software from the website listed in this manual.
- b) Install iConnect software on a networked PC. This software is compatible with Windows 95, 98, NT, 2000, and XP.
- c) Use iConnect to assign an IP address to the Meter and access its web pages for configuration. You can also use any standard web browser to access the Wireless System' web pages. Consult with your IT department for obtaining an IP address.

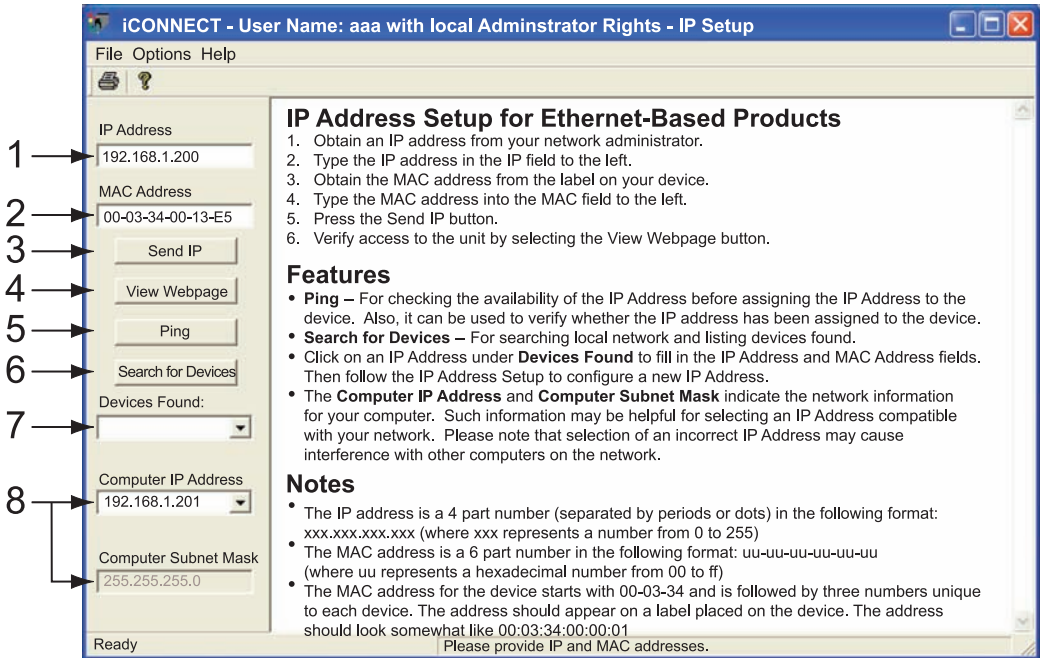
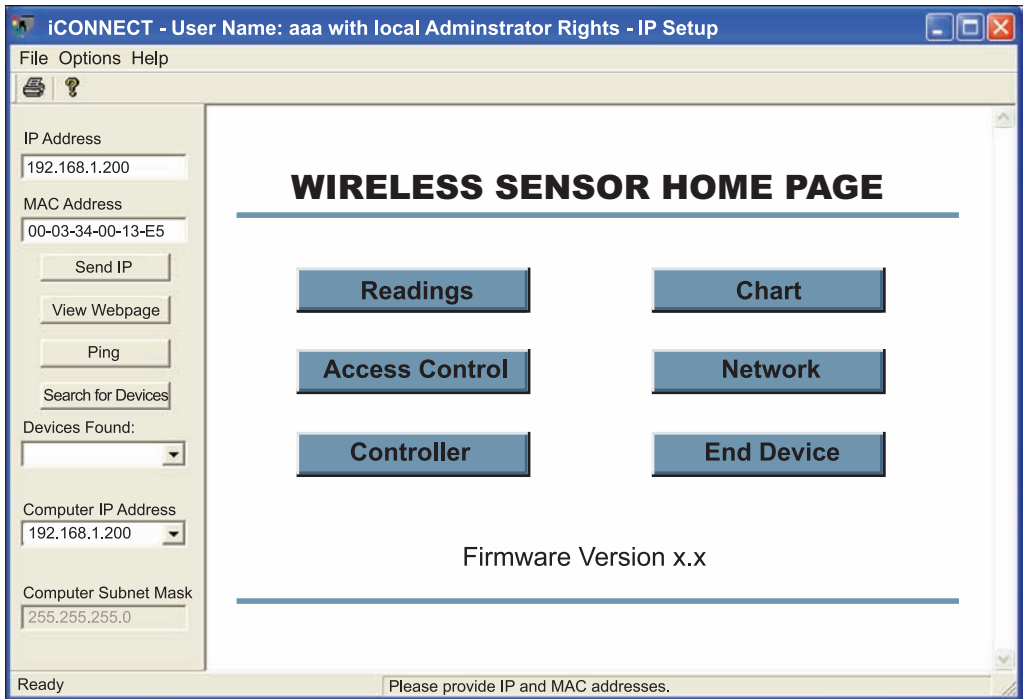

**Figure 4.2 Assigning an IP Address using iConnect**

- 1) Place the IP address in this box.
- 2) Take the MAC address from the label attached to the bottom of the Meter and place it in this box.
- 3) Click here to send the above IP address to the Meter.
- 4) After the IP address is assigned to the Meter, click here to access it's web pages.
- 5) Click here to Ping the Meter whose IP address is shown in the IP address box.
- 6) Click here to find all the Meters on your network .
- 7) The IP addresses for the Meters found by the iConnect will be listed here.
- 8) These fields indicate the IP address and the subnet mask of the PC on which the iConnect is running.

## 4.1 iConnect Software (continued)

- d) To access the Wireless System for Configuration:  
Click on the "View Webpage" button, you will access the Wireless System's home page, refer to **Section 4.3** for details.



**Figure 4.3 Accessing the Wireless System for Configuration**

## 4.2 Setting a New IP Address over the Network

Besides using the iConnect software, you may use the Meter's default IP address to access it and assign a new IP address to it.

The Meter is shipped with a default IP address of **192.168.1.200** and Subnet Mask of **255.255.255.0**. You can configure your PC's Network connection with an IP address that is in the same range as the Meter's IP address (**192.168.1.x**) and connect to the Meter using a crossover network cable between your PC and the Meter.

With this completed, you can go to the DOS-Prompt and ping **192.168.1.200**. If you receive responses back (**Figure 4.1**), you can go to the Web browser and type in **http://192.168.1.200** and it will take you to the Wireless System' Home Page.

Select  button, you'll be asked for the password. You should be on the Access Control page where you can simply type in the desired Static IP address, and click Save.

For more details about the "Access Control" page refer to **Section 4.3.10**.



ACCESS CONTROL

Address http://192.168.1.200

# ACCESS CONTROL

Login Password

Admin Password

Host Name

MAC Address

IP Address

Gateway Address

Subnet Mask

[Main Menu](#)

**Figure 4.4 Access Control**

For the IP address to take effect, the Meter needs to be turned OFF and ON using the "Network Reset" button. Pressing the physical button marked "RESET" on the Meter does the same thing.

You can now connect the Meter to an Ethernet hub using a straight through cable, power it up, and follow the ping routine mentioned in the previous section.

### 4.3 Meter's Configurations and Operations

Using a web browser, you should be able to view the Meter's homepage.

- Start your web browser.
- From the browser you type **http://wisxxxx** using the last four-digits from the MAC address label located on the Meter (see **Figure 3.1**), if DHCP and DNS are used. If a static IP address is used, then simply type **http://x.x.x.x**, where **x.x.x.x** is the Meter's IP address.
- The Home Page, will be displayed.

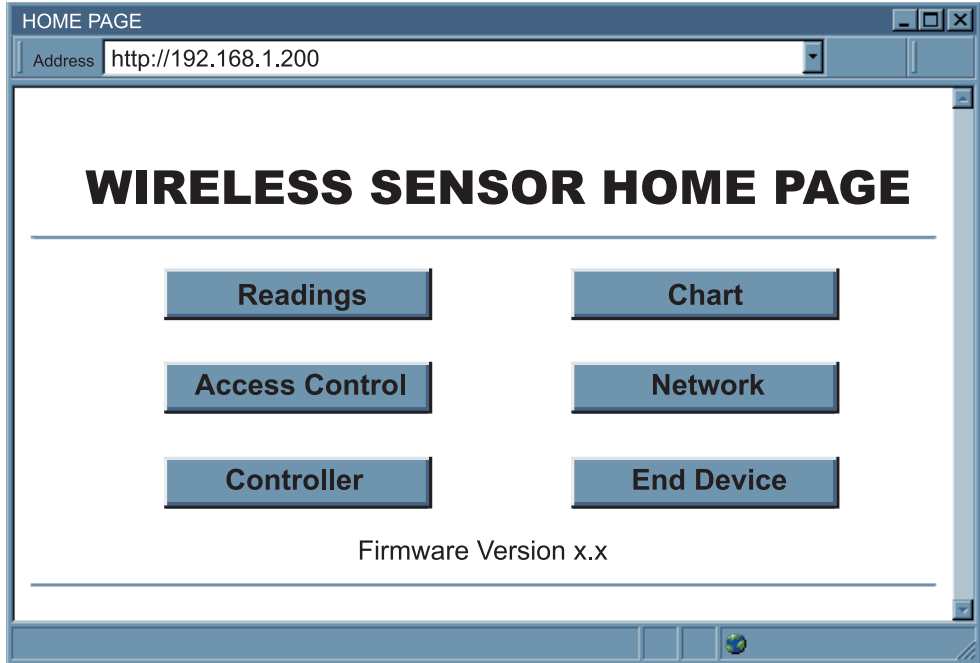
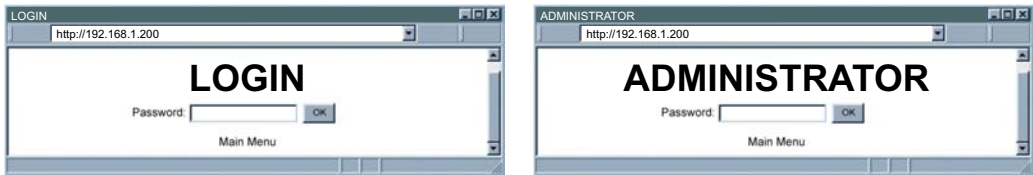

**Figure 4.5 Wireless System Home Page Menu**



In order to access certain menu items of the Home Page, users may be prompted for a password, as shown in the two following figures.

## 4.3 Meter's Configurations and Operations (continued)



**Figure 4.6 LOGIN and ADMINISTRATOR Passwords**

There are 2 different access levels:

1. ADMINISTRATOR Password (administrator) allows certain groups and individual users to access and modify parameters without any restrictions. The default password is **00000000**. This password can be up to 16 alphanumeric case-sensitive characters.
2. LOGIN Password (operator) allows users to access and modify all of the parameters, except "Access Control" which requires an Administrator password. The default password is **12345678**. This password can be up to 16 alphanumeric case-sensitive characters.

### 4.3.1 Power Up Meter

For instructions on how to power the Meter, refer to **Section 2.1.5**.

To verify that an End Device is working before deploying remotely, install the battery and power it on right next to the Meter. When the End Device is powered on, the green LED (TX) will blink periodically. This indicates the End Device is broadcasting its data to the Meter on channel 12 defined by IEEE 802.15.4.

The LED will blink only when the End Device sends data to the Meter. If the Meter is not powered on, or it's out of reach, the End Device will not receive the acknowledgment packet from the Meter and therefore to save battery power it will go to sleep.

The sleeping period can be defined by the users via the USB port (PC Configuration software) on the End Device. The End Device sends new data for a short period of time after every sleep period is over, until it can establish the connection back with the Meter.

**Note**

When there are two End Devices with the same Device ID/address, both will be transmitting data every sampling period with their LEDs blinking. The Meter will receive data from both End Devices and will display their data alternately. To avoid this, turn the End Device on one by one and verify that the Meter is displaying the correct data.



### 4.3.2 Get Readings from the End Device

Once you see the End Device's LED blinking periodically, it means it is sending data which will appear on the "Readings" page. To view the data in a chart format, you can use the "Chart" page.

Click on [Readings](#) from the Home Page, the following page will appear, showing updates of the Process and Ambient Temperature.

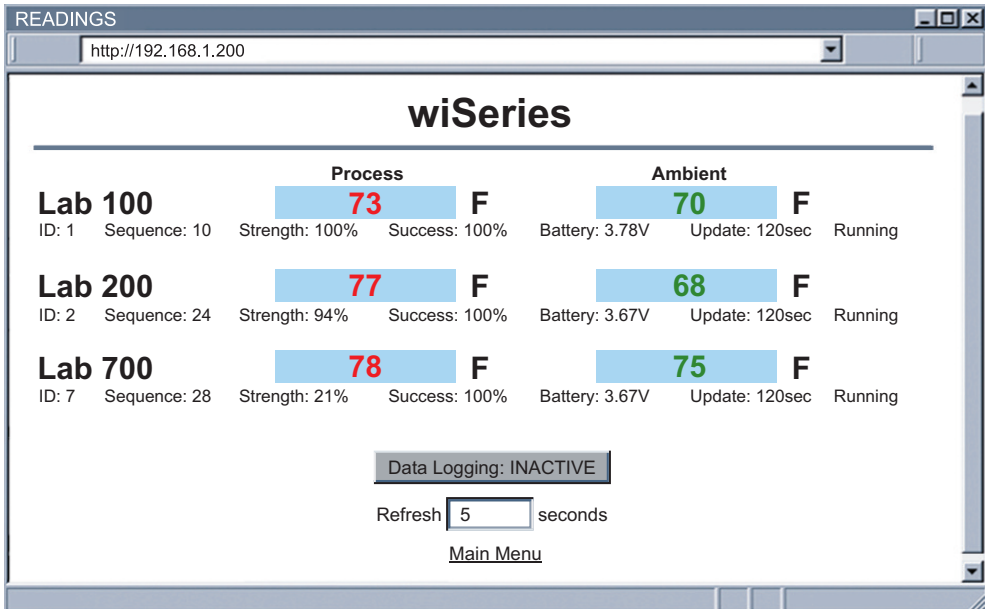

**Figure 4.7 Readings**

**Note** While accessing the "Readings" page, If a blank screen appears without any "java application running" or image of a "Java logo", please verify you have the latest Java Runtime Environment installed and configured according to the **Section 4.3.3.1**. If you do not have Java Runtime Environment, you may download it from our website or contact the Customer Service Department nearest you.

The "Readings" fields are defined as follows:

**Title:** Meter's name, assigned in Network Setup Menu.

**Name:** End Device's name, assigned in End Device Setup Menu.

**Reading Values:** The order from left to right is Process Temperature, then Ambient.

**First Reading:** Process - process temperature reading with temperature unit.

**Second Reading:** Ambient - built-in sensor temperature reading with temperature unit.

**Note** Reading "Open" indicates that no sensing device is detected.

### 4.3.2 Get Readings from the End Device (continued)

**ID:** End Device ID/address

**Sequence:** Sequence number [0-255].

The Sequence number is incremented for each newly received data. Therefore, it indicates if the sensor is transmitting data successfully.

**Strength:** It is the radio signal strength (0-100%), the higher the better.

**Success:** 0-100%, a low success rate indicates a longer data delay, shorter battery lifetime and high network traffic.

**Battery:** The total voltage of the battery in the End Device. Once the voltage gets to 3.0V, the batteries should be replaced.

**Update:** The time interval the Meter received data from the End Device.

**Running/Lost:** It displays "Running" if the Meter is receiving packages from the End Device. It displays "Lost" if the Meter has not received data from the End Device.

**Data Logging:** Press to activate/de-activate data logging. When it is pressed to activate data logging, a file browser pops up to ask for which file data will be saved. Data is in Comma Separated Value (csv) format, which can also be opened in Excel. Please name file with **.csv** extension.

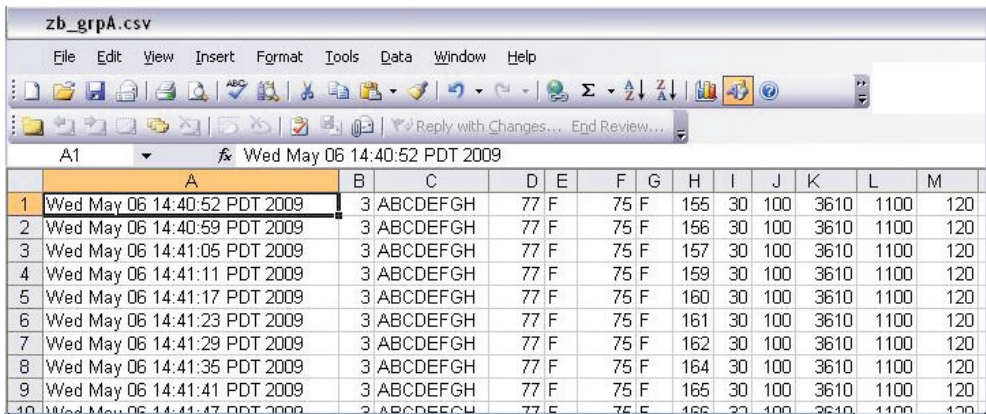

	A	B	C	D	E	F	G	H	I	J	K	L	M
1	Wed May 06 14:40:52 PDT 2009	3	ABCDEFGH	77	F	75	F	155	30	100	3610	1100	120
2	Wed May 06 14:40:59 PDT 2009	3	ABCDEFGH	77	F	75	F	156	30	100	3610	1100	120
3	Wed May 06 14:41:05 PDT 2009	3	ABCDEFGH	77	F	75	F	157	30	100	3610	1100	120
4	Wed May 06 14:41:11 PDT 2009	3	ABCDEFGH	77	F	75	F	159	30	100	3610	1100	120
5	Wed May 06 14:41:17 PDT 2009	3	ABCDEFGH	77	F	75	F	160	30	100	3610	1100	120
6	Wed May 06 14:41:23 PDT 2009	3	ABCDEFGH	77	F	75	F	161	30	100	3610	1100	120
7	Wed May 06 14:41:29 PDT 2009	3	ABCDEFGH	77	F	75	F	162	30	100	3610	1100	120
8	Wed May 06 14:41:35 PDT 2009	3	ABCDEFGH	77	F	75	F	164	30	100	3610	1100	120
9	Wed May 06 14:41:41 PDT 2009	3	ABCDEFGH	77	F	75	F	165	30	100	3610	1100	120
10	Wed May 06 14:41:47 PDT 2009	3	ABCDEFGH	77	F	75	F	166	30	100	3610	1100	120

**Figure 4.8 Comma Separated Value Format**

Columns from left to right: Date and time, Device ID, Device name, Reading 1, Unit 1, Reading 2, Unit 2, Sequence number, Signal strength, Success rate, Battery voltage, Status, Update, Next Device ID, Next Device name (up to 8 End Devices).

**ACTIVE** data is currently being logged in the specified file.

**INACTIVE** data logging is not executed.

**Refresh:** How often the current applet asks for data from the embedded server.

**Note** See **Section 4.3.4** before activating data logging.

### 4.3.3 Java Runtime Environment Setup

If your computer does not have Java installed, please download from [java.sun.com](http://java.sun.com). You can change the Java setting by clicking its icon in Control Panel. To load the applet, you have to enable the web browser and disable cache.

#### 4.3.3.1 Java Runtime Environment 1.5 (5.0) Setup Instructions

1. Go to your computer's Control Panel. Open the Java Plug-in
2. Click on "Settings" & "View Applets" in the "General" tab.
3. Select the "Settings" button on the General Tab  
Un-check the "Enable Caching" box. Then close dialog box to show the General Tab again
4. Select the "Network Settings" button on the General Tab.  
Proceed to the Browser tab. Follow the **Browser Proxy Selection** instructions below. You should either select the "Use Browser Settings" option or the "Direct Connection" option depending on the network connections between your computer and the Meter. (Generally, select "Direct Connection" if accessing the Meter on your local network and select "Use Browser Settings" option for access from your internal network to the internet.)
5. Refresh or restart the webpage.

For Java Version 1.5.x.x it is found under "General" > "Settings" > "View Applets" and then at the bottom there is the Checkbox to REMOVE CACHE .

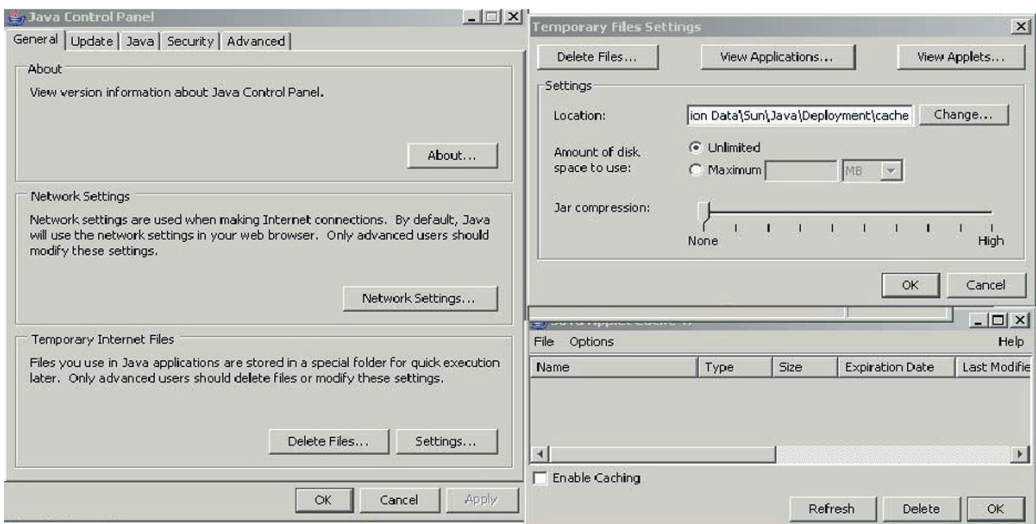

Figure 4.9 Java 1.5.x.x. Screen Shots



For Java 1.6.x.x it is similar to Java 1.5.x.x but there is no need to remove CACHE.

### 4.3.3.2 Java Runtime Environment 1.4 Setup Instructions

1. Go to your computer's Control Panel. Open the Java Plug-in
2. Select the "Cache" Tab  
Un-check the "Enable Caching" box
3. Select the "Proxy" Tab. Follow these **Browser Proxy Selection** instructions below. (Generally, un-check the box if accessing the Meter on your local network and check the box for access from your internal network to the internet.)
4. Refresh or restart the webpage.

To disable cache setting:

For Java Version 1.4.2.x it is found under the CACHE TAB.

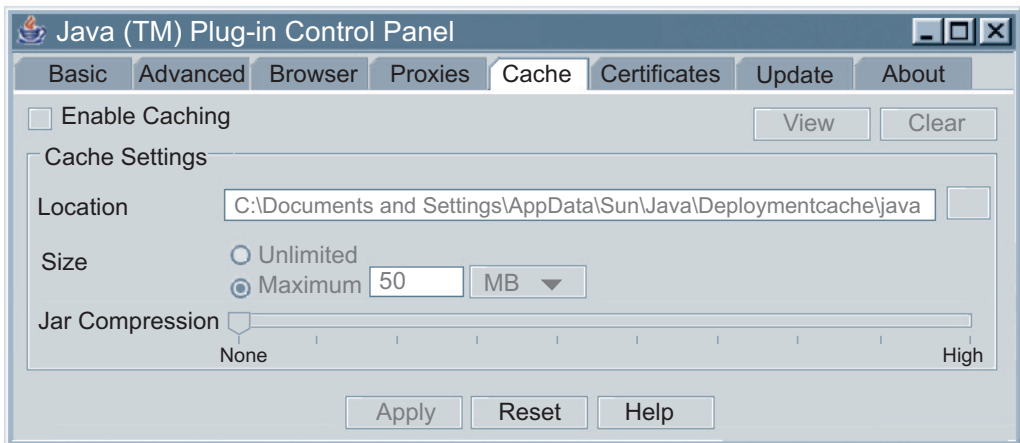

Figure 4.10 Java 1.4.2.x Screen Shot

### 4.3.3.3 Browser Proxy Selection

#### Accessing Meter units within your internal network

- Usually when the computer and Meters are on an internal network, you will not use Proxy server access.
- You should un-check the "Use Browser Settings" option on the "Proxy" tab.

#### Accessing Meter units using the internet

- Often the web browser will use Proxy server access to the internet. In such cases, the default Java runtime settings on the "Proxy" tab should suffice. The default setting is the "Use Browser Settings" option.
- If the default proxy setting doesn't work, then you may have a situation where the proxy settings of the web browser are incorrect.

#### Diagnostics:

If the web page of the Wireless System appears, then the HTTP Proxy is working fine.

If the data isn't updated on the Wireless System upon selecting the "Readings" page, there may be a problem with access through a winsock proxy server. In such cases your network administrator will need to provide the winsock proxy server and port #s. (The TCP ports the Meter uses for Java applets are 1000 and 2003).

These values should be entered into the Socks line on the "Proxy" tab (of the Java Plugin control panel) or into the "connections" tab on the View,Internet Options dialog and make sure that the Proxy tab shows that the "Use Browser Settings" option is not selected (i.e. when you specify proxy connections in the Java Plugin control panel).

#### Accessing Meter units over Peer-to-Peer network

A simple peer-to-peer network is setup by disconnecting from the main network (as users will often do when trying to do initial setup of the Meter) and then connecting the Meter to another computer using an ethernet hub, an ethernet switch, or a Cross-over cable connection.

Often when using a peer-to-peer network, the Java plugin and the web browser (such as Internet Explorer) have internet connections configured to connect through proxy servers. In such case, you will need to simply assign the final IP address on this peer to peer network and then view the Wireless System's charts after connecting the Meter into the regular network. Otherwise you can disable the Java plug-in's "Use Browser Settings" temporarily and then reconfigure the Java plug-in settings for regular network access after testing the Wireless System's chart access on your peer-to-peer network.

The "Use Browser Settings" should not be selected. And the HTTP and Socks proxy entries should be blank. Also, setup the internet browser so that proxy servers are disabled.

Java and the Java Coffee Cup Logo are trademarks or registered trademarks of Sun Microsystems, Inc. in the U.S. and other countries."

### 4.3.4 Java Policy

To activate data logging and save graphs from the Java applets, it is necessary to create a Java Policy file and copy it onto a folder.

- 1) Open a Notepad file and using the IP address of the Meter type the following:

```
grant codeBase "http://192.168.1.200/"
{
    permission java.security.AllPermission "*", "*";
};
```

**Note**

This file should have the IP address of the Meter; in this case the default IP address is 192.168.1.200. If the IP address is changed, then the IP address shown in the file needs to be changed; otherwise, it will not work. If more than one Meter is being monitored from the same computer, it is necessary to repeat the above for each of the Meters in the same "java\_policy.txt" file.

If DHCP/DNS is enabled, the unique Meter's name using DNS should replace the IP address. Example: "http:\\zSrvTEST". Make sure the DHCP server updates the DNS table to keep track of the Meter's name and IP addresses (consult with your network administrator).

- 2) Save the file as java\_policy.txt.
- 3) Create a folder in your C: drive called "0\_JAVAPOLICY".
- 4) Place the java.policy.policy file into the "0\_JAVAPOLICY" folder.

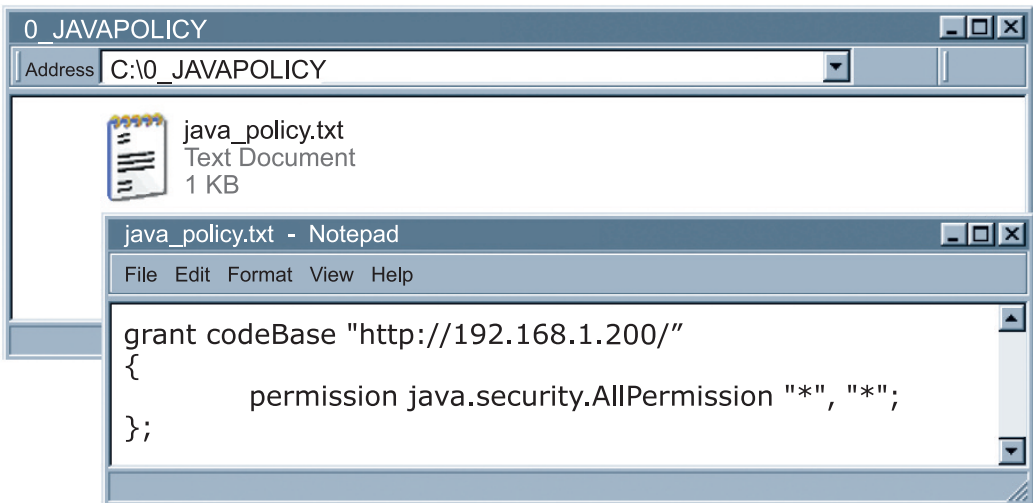

**Figure 4.11 Java Policy**

### 4.3.4 Java Policy (continued)

- 5) Change Java Applet's Runtime Parameters found on the following path:
  - a. Control Panel --> Java --> Java Control Panel --> Java Tab --> View
  - b. Inside the box under the Java Runtime Parameters type the following:  
**-Djava.security.policy=C:\0\_JAVAPOLICY\java\_policy.txt**
  - c. Click OK on the Java Runtime Settings window.
  - d. Click Apply on the Java Control Panel window and then OK.
- 6) Close all opened Web browser.

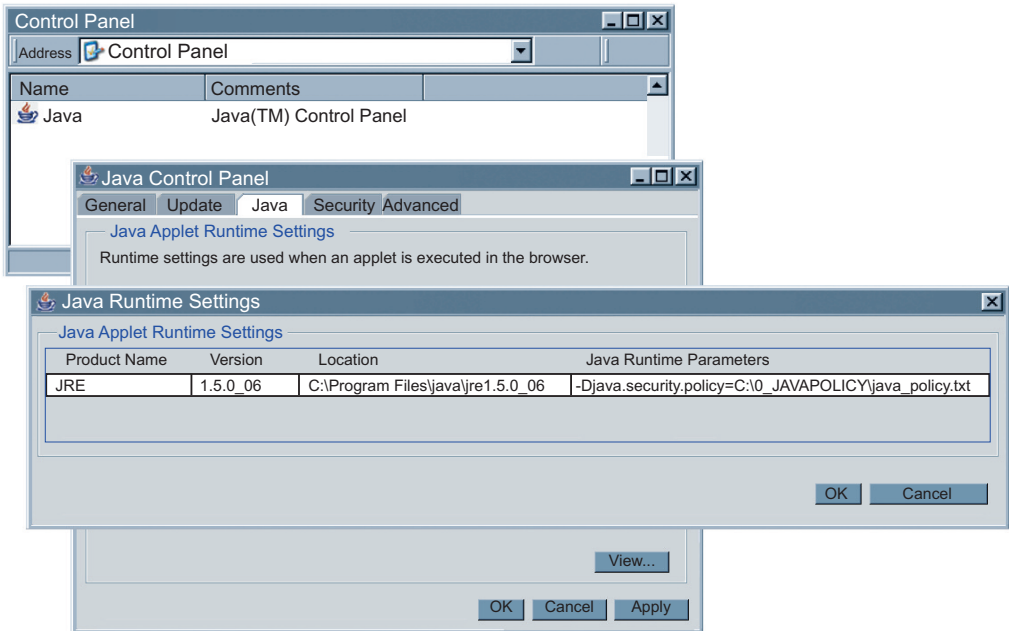

**Figure 4.12 Java Policy**

**Note**

The "Data Logging" and "Save Current Graph" buttons in the "Readings" and "Chart" pages will not be active if the instructions explained in the above **Section 4.3.4** are not followed.

### 4.3.5 Chart

Click on  from the Home Page, the following page will appear.

The Java™ Applet graph displays Process Temperature and Ambient Temperature. It can be charted across the full span or within any narrow range (such as 20 to 30°C).

**Note**

If a blank screen appears without any "java application running" or image of a "Java logo", please verify you have the latest Java Runtime Environment installed and configured according to the instructions (refer to **Section 4.3.3.1**). If you do not have Java Runtime Environment, you may download it from our website or contact the Customer Service Department nearest you.

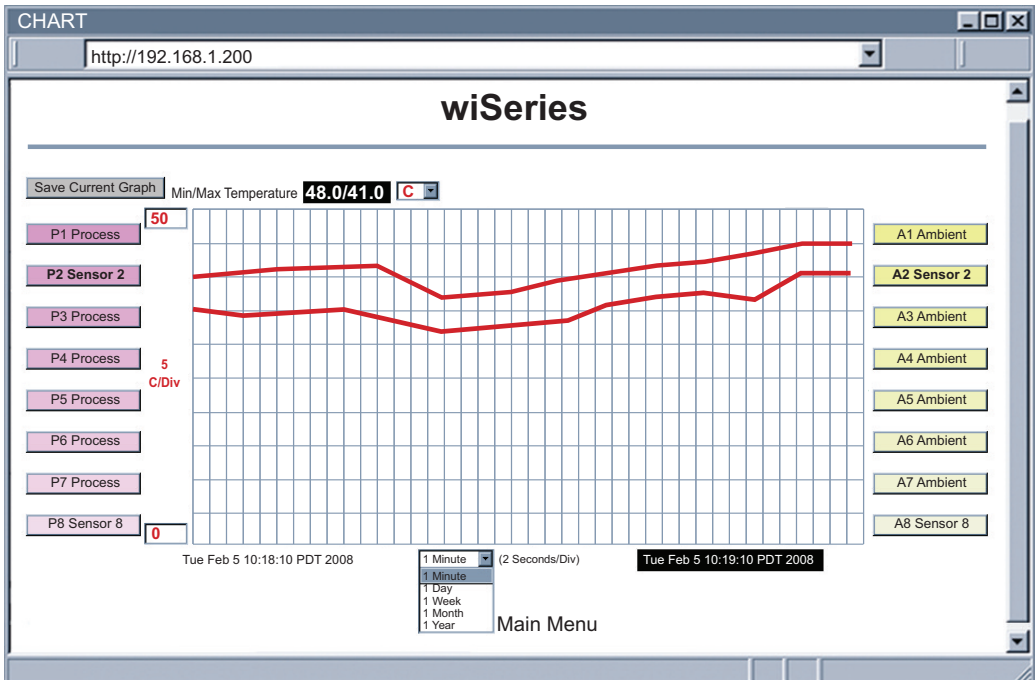

Figure 4.13 Chart



### 4.3.5 Chart (continued)

**Title:** Meter's name, assigned in "Network Setup" page.

**Save Current Graph:** Save the current graph in PNG (Portable Network Graphics) format. The filename has the extension **.png**.

**Max/Min Temperature:** Maximum and minimum temperature of the current graph.

If a sensor is selected (trend line and sensor name turns bold), its most current temperature reading is shown here.

**Note**

Reading "Open" indicates that no sensing device is detected.

**Temperature Unit:** Temperature unit to be used, either °C or °F.

**P# button (Process):** P# shows the sensor name (assigned in the End Device Setup Menu) and controls the process sensor readings.

When clicked *once*, it turns bold, highlights the process sensor trend line and displays current sensor readings.

When clicked *twice*, it turns white and the trend line will disappear.

When clicked again, it comes back to normal operation.

**Chart Area:** Display the trend lines of the sensors.

Range of temperature can be controlled by the upper and lower boxes on the left.

**A# button (Ambient):** A# shows the sensor name (assigned in the End Device Setup Menu), displays error messages [Lost] and controls the ambient sensor readings.

When clicked *once*, it turns bold, highlights ambient sensor trend line and displays current sensor readings.

When clicked *twice*, it turns white and the trend line will disappear.

When clicked again, it comes back to normal operation.

**Applet Start Date and Time:** Activates when the "Chart" page opens up.

**X-axis Drop-down List:** Time scale for the chart.

The chart area can be shown based on 1 min, 1 hour, 1 day, 1 week, 1 month, or 1 year time intervals.

**Last Update Date and Time:** The last date and time when data arrived.

### 4.3.6 Controller Setup

The Meter has two modes of operations. One is through the Front Panel Buttons (please refer to **Front Panel Supplement** for more details), and the other is by using the browser to configure the settings. Click on **Controller** from the Home Page. In a few seconds the following page will appear.

The screenshot shows a browser window titled "CONTROLLER SETUP" with the address "http://192.168.1.200". The main content area is divided into sections: "Setup", "Monitor", "Transmission Power", and "Misc.". Callout A points to the "Alarm 1" and "Alarm 2" links in the Setup section. Callout B points to the "Update" button in the Monitor section. Callout C points to the "Update" button in the Transmission Power section. Callout D points to the "Main Menu" link at the bottom of the page.

**Setup**

Input

Setpoints & On/Off

Alarm 1

Alarm 2

Display

Passcode ID

Enable Standby Mode Before Configuring Unit

**Monitor**

Scrolling

End Device ID

Permanent Store

**Transmission Power**

Channel 12

Transmission Power

Please refer to local regulations for the allowed maximum transmission power

**Misc.**

PID 13106 (version x.x)

iSeries Firmware Version x.x

Main Menu

**Setup**

Input

Setpoints & On/Off

Analog Out

Alarm 2

**Note** This portion of the menu will be different only if you have the Analog Output Option installed in your Meter.

 Please refer to local regulations for the maximum allowed transmission power.

Figure 4.14 Controller Setup

### 4.3.6 Controller Setup (continued)

Below are the definitions of terms used in the Controller Setup page.

#### A) Setup:

Clicking on the options shown, allows user to modify the different parameters shown under this menu (see **Section 4.3.7**. Setup Page for more details)

#### B) Monitor:

**Scrolling:** If checked, the Meter will display data from all the End Devices. Otherwise, it only displays data from the End Device specified on Device ID.

**End Device ID:** Address/ID of the End Device that will be display on the Meter.

#### C) Transmission Power:

**Channel 12:** The Meter communicates in a fixed channel. Operation channel #12 defined in IEEE 802.15.4 for the sensor network.

**Transmission Power:** This determines the signal power transmitted by the Meter. The options are 10 dBm and 20 dBm.



Please refer to local regulations for the allowed maximum transmission power.

For additional details, please refer to **Appendix F**

#### D) Miscellaneous:

**PID 13106 (version):** The Personal Network ID is fixed to 13106. In parenthesis is the firmware version of the radio module. The firmware version is also shown on a label attached to the Meter (see **Figure 3.1**).

**iSeries Version:** The firmware version of the Meter. The firmware version is also shown on a label attached to the Meter (see **Figure 3.1**)

### 4.3.7 Setup

This section is used to configure the Meter online. Click on the specific settings to change the parameters on that section

#### 4.3.7.1 Input

**Control End Device ID:** Insert the End Device ID number that will be used as input to control

**Filter:** This option allows the user to specify the number of readings stored in the Digital Averaging Filter. Choice of: 1, 2, 4, 8, 16, 32, 64, 124.

**Temperature Unit:** Unit of temperature readings, [ °C or °F ].

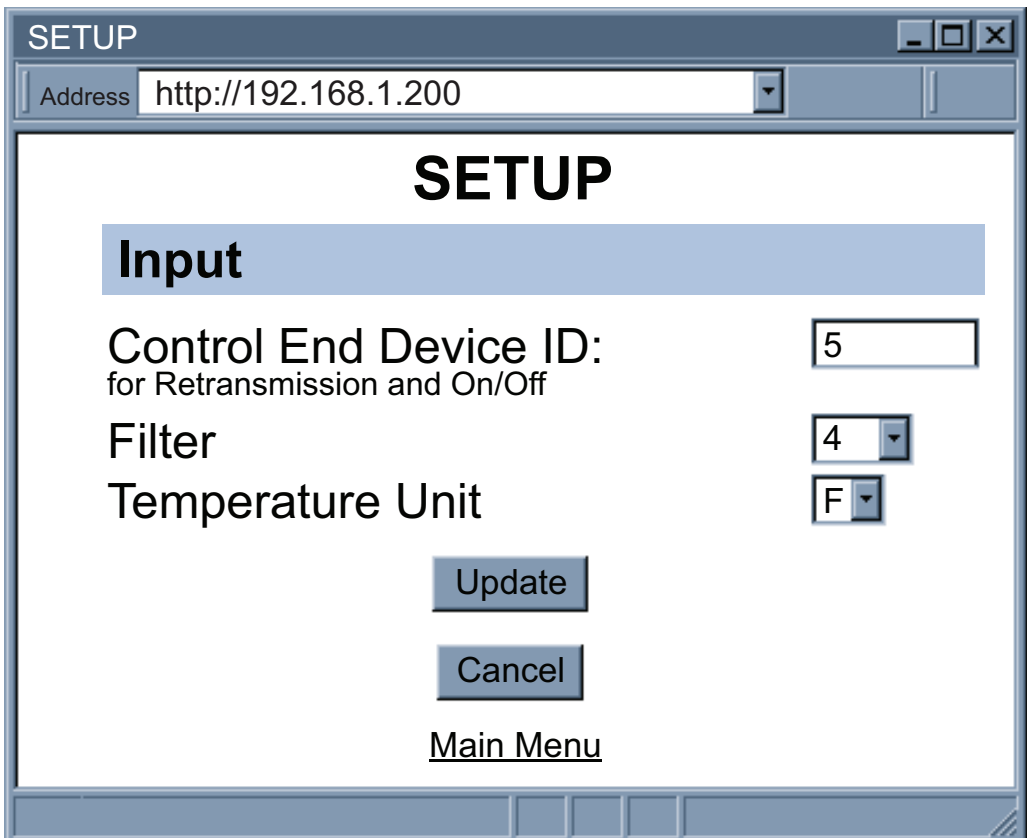

The screenshot shows a web browser window titled "SETUP". The address bar contains "http://192.168.1.200". The main content area is titled "SETUP" and has a sub-section titled "Input". Under "Input", there are three configuration items: "Control End Device ID: for Retransmission and On/Off" with a text input field containing "5"; "Filter" with a dropdown menu showing "4"; and "Temperature Unit" with a dropdown menu showing "F". Below these items are three buttons: "Update", "Cancel", and "Main Menu".

Figure 4.15 Input

### 4.3.7.2 Setpoints & On/Off Control

**Auto Setpoint Deviation:** If "enabled", allows changes to Setpoint 1 to be made automatically to Setpoint 2. This mode is very helpful if the Temperature changes often.

In Setpoint Deviation Mode, set SP2 a certain number of degrees or counts away from SP1--this relation remains fixed when SP1 is changed.

For instance:

Setting SP1=200 and SP2=20 and enabling SP Deviation means that the absolute value of SP2=220.

Moving SP1 to 300, the absolute value of SP2 becomes 320.

**Setpoint 1:** This setpoint controls Output 1

**Setpoint 2:** This setpoint controls Output 2

**Permanent Store:** Check to save Setpoints in the Meter's permanent storage.

**On/Off 1 and On/Off 2:** To enable and disable On/Off Control. Enabling On/Off Controls will disable the Alarms, and vice versa.

**DeadBand:** The Dead Band or neutral zone, is the number of degrees counts around Setpoint 1 (or Setpoint 2 if On/Off 2) which the temperature value must pass above or below the Setpoint before the output changes state.

**Action:** Choice of *direct* or *reverse*. The error that results from the measurement of the Process Variable may be positive or negative since it may be greater or smaller than the Setpoint.

If a positive error should cause the Meter output to increase (i.e. cooling), it would be called **Direct Acting**.

If a negative error should cause the output to increase (i.e. heating), it would be called **Reverse Acting**.

### 4.3.7.2 Setpoints & On/Off Control (continued)

Address

## SETUP

### Setpoints & On/Off Control

Auto Setpoint Deviation	<input type="text" value="Disabled"/>
Setpoint 1	<input type="text" value="0"/>
Setpoint 2	<input type="text" value="100"/>
Permanent Store	<input checked="" type="checkbox"/>
<b>On/Off 1</b>	<input type="text" value="Disabled"/>
DeadBand	<input type="text" value="0"/>
Action	<input type="text" value="Reverse"/>
<b>On/Off 2</b>	<input type="text" value="Disabled"/>
DeadBand	<input type="text" value="0"/>
Action	<input type="text" value="Direct"/>

[Main Menu](#)

Figure 4.16 Setpoints & On/Off Control

### 4.3.7.3 Alarms 1 & 2

**Alarm 1 (or 2) Relay:** to enable or disable (no alarm function) the alarms .

**Alarm 1 (or 2) Low:** editable box for the low alarm value.

**Alarm 1 (or 2) High:** editable box for the high alarm value.

**Active:** If *Above*, Alarm condition triggered when the process variable is greater than the Alarm Hi Value (Low value ignored).

If *Below*, Alarm condition triggered when the process variable is less than the Alarm Low Value (Hi value ignored).

If *Hi/Low*, Alarm condition triggered when the process variable is less than the Alarm Low Value or above the Hi Value.

If *Band*, Alarm condition triggered when the process variable is above or below the "band" set around the Setpoint. Band equals Hi Value (Low Value ignored).

 **Note** A "band" is set around the Setpoint only in the "Deviation" Mode.

**Normally:** if *Open*, then the relay is "energized" only when an alarm condition occurs.

If *Closed*, this is "Fail Safe" Mode. Relay is energized under "normal" conditions and becomes de-energized during alarm or power failure.

**Latch:** if *Latched*, Alarm remains "latched" until reset.

If *Unlatched*, Alarm remains latched only as long as the alarm condition is true.

**Absolute:** if *Absolute*, this allows Alarms to function independently from their respective Setpoints. If the process being monitored does not change often, then "Absolute" Mode is recommended.

If *Deviation*, this allows changes to Setpoints to be made automatically to their corresponding Alarms. Deviation Mode is typically the ideal mode if the process temperature changes often. In Deviation Mode, set Alarm 1 a certain number of degrees or counts away from Setpoints, this relation remains fixed even if Setpoints are changed.

**Alarm at Power On:** If the alarm is *enabled* at Power On, the alarm will be active right after reset for all the End Devices (given the conditions are met), except the End Device designated in the "Input" menu of the Web Server.

If the alarm is *disabled* at Power On, the alarm will become enabled when the process value enters the non alarm area. The alarm is not active while the process value is approaching the Setpoints.

 **Note** Errors indicating "lost" or "open" sensor condition can trigger the alarm if the alarm is set for "active high" above 9000 degrees.

### 4.3.7.3 Alarms 1 & 2 (continued)

**SETUP**

Address

## SETUP

### Alarm 1

Alarm 1 Relay	<input type="text" value="Enabled"/>
Alarm 1 Low	<input type="text" value="0"/>
Alarm 1 High	<input type="text" value="100"/>
Active	<input type="text" value="Above"/>
Normally	<input type="text" value="Open"/>
Latch	<input type="text" value="Unlatched"/>
Absolute	<input type="text" value="Absolute"/>
Alarm at Power On: Alarm could be triggered immediately by non-controlling end device at startup.	<input type="text" value="Enabled"/>

[Main Menu](#)

Figure 4.17 Alarms 1 & 2



### 4.3.7.4 Analog Output Retransmission



This menu will appear only if you have the Analog Output Option installed in your Meter.

Address

## SETUP

### Analog Output Retransmission

Retransmission	<input type="text" value="Enabled"/>
Voltage/Current	<input type="text" value="Voltage"/>
Input Low	<input type="text" value="0"/>
Output Low	<input type="text" value="0.00"/> Min. 0V
Input High	<input type="text" value="1000"/>
Output High	<input type="text" value="10.00"/> Max. 10V

[Main Menu](#)

**Figure 4.18 Analog Output Retransmission**

**Retransmission:** When *enabled*, the input data will be scaled based on Input Low and Input High and will be outputted. If the input reaches high value the output will be 10V or 20mA. If the input reaches low value, the output will be 0V or 0mA.

**Voltage/Current:** Select the output to be *Voltage* (0-10V) or *Current* (0-20mA).

**Input Low:** The minimum input value scaled for Output Low.

**Output Low:** Output Voltage or Current represented by Input Low.

**Input High:** The minimum input value scaled for Output High.

**Output High:** Output Voltage or Current represented by Input High.

### 4.3.7.5 Display

This submenu allows the user to select the color of the display--green, red, amber.

**Screen Update:** Editable box to enter the display time in seconds between each End Device.

**Normal:** Choose the display color of temperature when it is in the normal stage.

**Alarm 1:** Choose the display color of temperature when alarm 1 is true.

**Alarm 2:** Choose the display color of temperature when alarm 2 is true.

**Tip** In order to display one color, set the same display color on all three submenus.

**Note** If user wants the Display to change color every time when both Alarm 1 and Alarm 2 are triggered, the Alarm values should be set in such a way that Alarm 1 value is always on the top of Alarm 2 value, otherwise value of Alarm 1 will overwrite value of Alarm 2 and Display Color would not change when Alarm 2 is triggered.

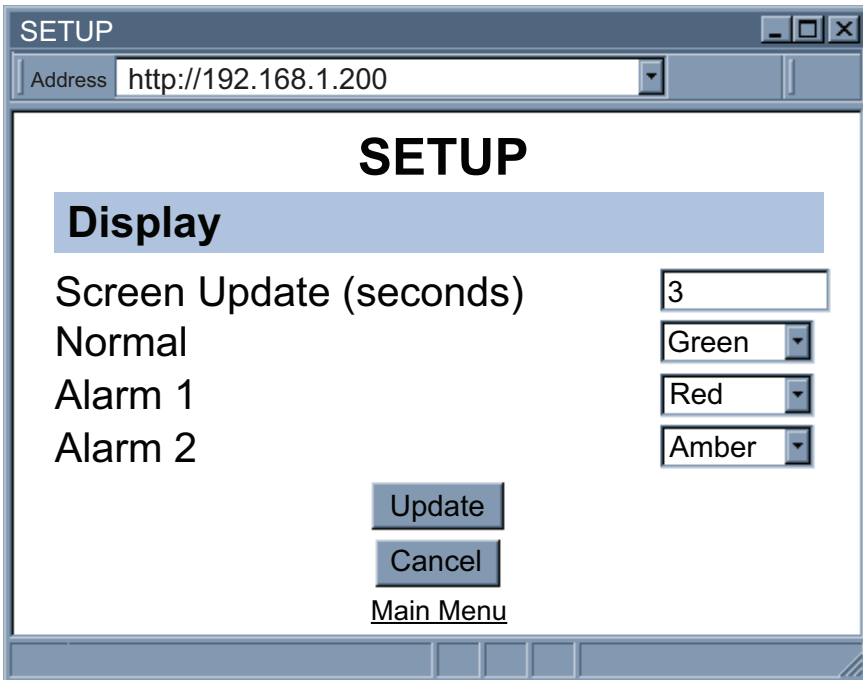

Figure 4.19a Display Menu

### 4.3.7.5 Display (continued)



This version of the menu will appear only if you have the Analog Output Option installed in your Meter.

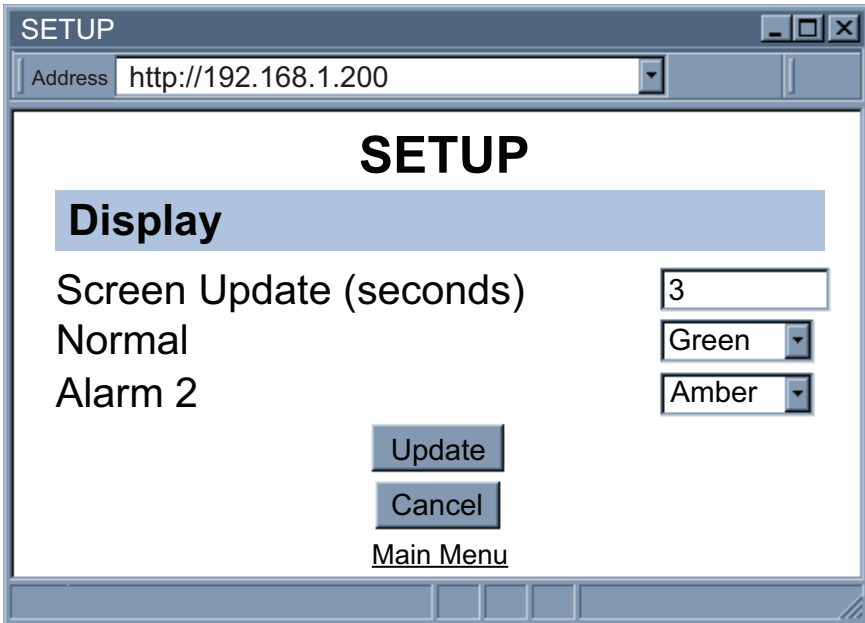

Figure 4.19b Display Menu (if Analog Output Option)

### 4.3.7.5.1 Display Color Examples

#### Example 1:

Output 1 & Output 2 = SSR

Alarm Setup: Absolute, Above, Alarm 2 HI Value "**ALR.H**" = 200,

Alarm 1 HI Value "**ALR.H**" = 400

"Color Display" Setup: Normal Color "**N.CLR**" = Green,

Alarm 1 Color "**1.CLR**" = Amber, Alarm 2 Color "**2.CLR**" = Red

Display Colors change sequences:



#### Example 2:

Output 1 & Output 2 = Pulse

Alarm Setup: Absolute, Below, Alarm 2 Low Value "**ALR.L**" = 300,

Alarm 1 Low Value "**ALR.L**" = 100

Color Display Setup: "**N.CLR**" = Green, "**1.CLR**" = Amber, "**2.CLR**" = Red

Display Colors change sequences:



### 4.3.7.5.1 Display Color Examples (continued)

#### Example 3:

Output 1 = Relay, Setpoint 1 = 300,

Output 2 = Relay, Setpoint 2 = 200

Alarm 1 & 2 Setup: Deviation, Band, "**ALR.H**" = 10

Color Display Setup: "**N.CLR**" = Green, "**1.CLR**" = Amber, "**2.CLR**" = Red

Display Colors change sequences:

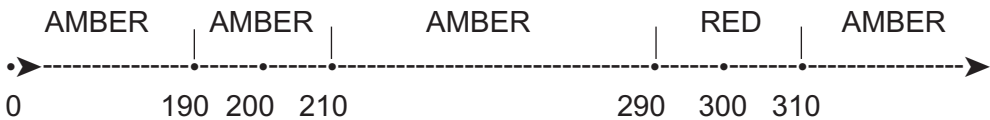

**Tip** <sup>ES</sup> Alarm 1 is designed to monitor the Input Value around the Setpoint 1. Alarm 2 is designed to monitor the Input Value around the Setpoint 2.

#### Example 4:

Output 1 = Relay, Setpoint 1 = 200

Output 2 = Relay, Setpoint 2 = 200

Alarm 1 Setup: Deviation, Band, "**ALR.H**" = 20

Alarm 2 Setup: Deviation, Hi/Low, "**ALR.H**" = 10, "**ALR.L**" = 5

Color Display Setup: "**N.CLR**" = Green, "**1.CLR**" = Amber, "**2.CLR**" = Red

Display colors change sequences:



### 4.3.7.6 Passcode ID

To prevent unauthorized tampering with the setup parameters, the Meter provides protection by requiring the user to enter the ID Code before allowing access to subsequent menus of the Meter's front panel. If the ID Code entered does not match the ID Code stored, the Meter responds with an error message and access to subsequent menus will be denied.

**Setpoint ID:** If *enabled*, ID Code is set to Setpoint ID Security Level and if a user attempts to enter the Configuration Menu, using the Front Panel Buttons, they will be prompted to enter an ID Code.

**Full ID:** If *enabled*, ID Code is set to Full Security Level and if a user attempts to enter the Main Menu, using the Front Panel Buttons, they will be prompted to enter an ID Code.

**ID:** editable box to enter the 4 digit ID Code. Default is 0000.

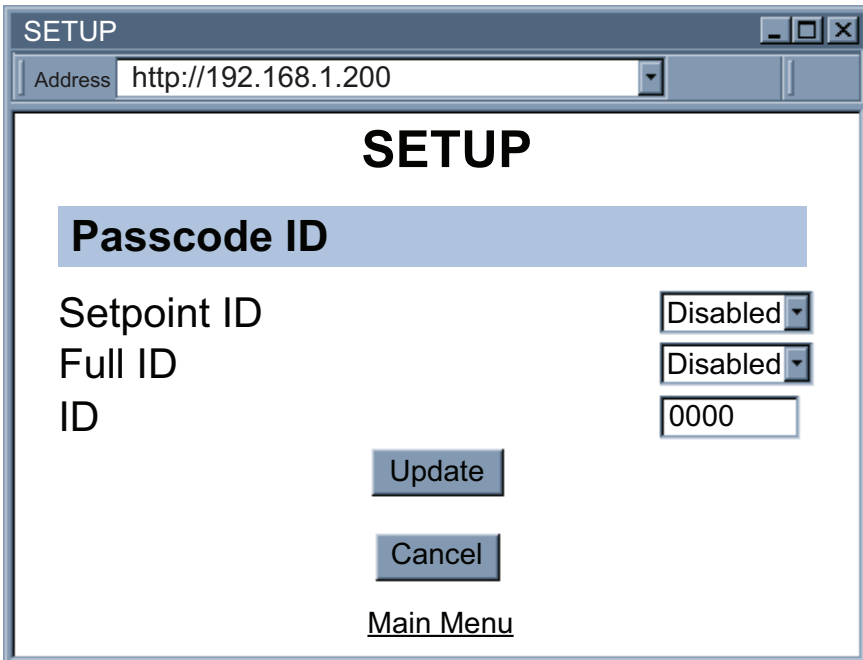

Figure 4.20 ID Code

### 4.3.8 Network Setup

Click on [Network Setup](#) from the Home Page, the following page will appear.

**NETWORK SETUP**

Address <http://192.168.1.200>

## NETWORK SETUP

### General

Secured Applet

Title

---

### Terminal Server

TCP/UDP

Server Type

Forward CR

Number of Connections

Port

---

### Remote Access (Tunneling)

Remote IP Address

Remote Port

Remote Access

[Main Menu](#)

**A**

**B**

**C**

Figure 4.21 Network Setup

## 4.3.8 Network Setup (continued)

### A) General

**Secured Applet:** If checked, the LOGIN password is required to open "Readings" and "Chart" pages.

**Title:** Meter's name [maximum of 16 alphanumeric characters], shows on the "Chart" and "Reading" pages.

### B) Terminal Server

**TCP/UDP\*:** The Meter supports *TCP* and *UDP* protocols (default is *TCP*). If *UDP* is selected, it can be configured either for Broadcast *UDP* or Directed *UDP*. In case of Broadcast *UDP*, the Meter will transmit the data to every node on the network. This can be accomplished if the Remote IP Address is set to 255.255.255.255. The Broadcast *UDP* is a practical solution when one Meter needs to communicate with multiple nodes over the network. In the case of directed *UDP*, the Meter will transmit the data to a specific node on the network. This can be accomplished if the Remote IP Address is set to the IP address of that specific node.

**Server Type:** *Continuous* mode sends the temperature to the Ethernet, every two seconds. It is mainly used to send readings to a remote display. *Command* mode (default) needs a command to query the Meter to send the response back to querying device.

**Forward CR:** Forward CR can be *enabled* and *disabled*. If enabled the Meter will forward a <CR> along with the data to a network host in Command mode

**Number of Connections:** The range is from 0 to 5. If 0 is selected, the Terminal Server feature is disabled. This means that no network connection can be made to the Meter. If 1 is selected, only one network connection can be made to the Meter. Any number more than 1 would allow that number of network hosts to read from the Meter simultaneously (default is 5).

**Port:** Port number for TCP connections. Invalid ports: <500, >65536, 1000, 2002, 2003, and 7011.

### C) Remote Access

**Remote IP Address:** The Meter can establish a connection to a remote device (e.g. an iLD Remote Display with an Ethernet embedded board) with this IP.

**Remote Port:** (default 2000) the remote port number for the connection.

Ports 1000 (used for HTTPget, refer to **Section 4.5**), 2002, 2003, and 7011 are reserved for internal use.

**Remote Access:** \*\* Remote Access can be enabled and disabled. If enabled, the Meter can send its data to a remote node on the same network (the "Remote IP address" and "Remote Port" must be entered).

**Note**

\* TCP/UDP: when *UDP* mode and *Continuous* are selected, Remote Access should be disabled and Remote IP and Port are the *UDP* remote listening IP and Port. If the Remote IP is set to 255.255.255.255, the *UDP* packet becomes a broadcasting packet which will allow any device listening to the Remote port to receive the packet.

\*\* If Remote Access is enabled, Terminal Server is automatically disabled.

**Update:** Saves and Updates any changes on the "Network Setup" page.



### 4.3.9 End Device Setup

Click on [End Device](#) from the Home Page, the following page will appear.

ID	Name	Update	Network	Units	Remote	Format	EndChar	Display	Alarm
<u>1</u>	Lab 100	120	<input checked="" type="checkbox"/>	F		0000000F	0D	<input checked="" type="checkbox"/>	<input checked="" type="checkbox"/>
			<input checked="" type="checkbox"/>	F		0000000F	0D		
<u>2</u>	Lab 200	120	<input checked="" type="checkbox"/>	F		0000000F	0D	<input checked="" type="checkbox"/>	<input checked="" type="checkbox"/>
			<input checked="" type="checkbox"/>	F		0000000F	0D		
<u>3</u>	ABCDEFGH	0	<input checked="" type="checkbox"/>	F		0000000F	0D	<input type="checkbox"/>	<input type="checkbox"/>
			<input checked="" type="checkbox"/>	F		0000000F	0D		
<u>4</u>	ABCDEFGH	0	<input checked="" type="checkbox"/>	F		0000000F	0D	<input type="checkbox"/>	<input type="checkbox"/>
			<input checked="" type="checkbox"/>	F		0000000F	0D		
<u>5</u>	ABCDEFGH	0	<input checked="" type="checkbox"/>	F		0000000F	0D	<input type="checkbox"/>	<input type="checkbox"/>
			<input checked="" type="checkbox"/>	F		0000000F	0D		
<u>6</u>	ABCDEFGH	0	<input checked="" type="checkbox"/>	F		0000000F	0D	<input type="checkbox"/>	<input type="checkbox"/>
			<input checked="" type="checkbox"/>	F		0000000F	0D		
<u>7</u>	Lab 700	120	<input checked="" type="checkbox"/>	F		0000000F	0D	<input checked="" type="checkbox"/>	<input checked="" type="checkbox"/>
			<input checked="" type="checkbox"/>	F		0000000F	0D		
<u>8</u>	ABCDEFGH	0	<input checked="" type="checkbox"/>	F		0000000F	0D	<input type="checkbox"/>	<input type="checkbox"/>
			<input checked="" type="checkbox"/>	F		0000000F	0D		

Click on End Device ID to modify Sensor Parameters.  
Network: Access Data from Network/Applet  
Display: Display Reading during Scrolling  
Alarm: Enable to Trigger Controller Alarm

[Update](#)

[Readings](#)

[Chart](#)

[Main Menu](#)

Figure 4.22 End Device Setup

### 4.3.9 End Device Setup (continued)

The End Device Setup Page is for configuring the End Device parameters such as Name and Update Rate.

**#:** End Device ID/address configured on the End Device. Click on the number (1 to 8) to view device and modify End Device Parameters.

**Name:** Name of an End Device, shows on the "Readings" and "Chart" pages. It is modified on the "End Device Parameters" page.

**Update:** How often the Meter is expected to receive data from an End Device. It is modified on the "End Device Parameters" page.

**Network:** Each check box controls whether or not readings from the End Device will be outputted.

If unchecked, the reading from the End Device will not be displayed on the "Readings" and "Chart" pages nor it will be reported through Telnet.

Each End Device has two boxes assigned: the first is for the process sensor, and the second is for the ambient sensor.

**Units:** Type of data and the corresponding units [ $^{\circ}\text{C}$  or  $^{\circ}\text{F}$ ].

Units of measurement from sensors inside an End Device that has joined the network will be displayed.

It is modified on the Controller Setup "Input" page.

**Remote Format:** Modified on the "End Device Parameters" page.

**End Char:** Modified on the "End Device Parameters" page.

**Display:** Modified on the "End Device Parameters" page.

**Alarm:** Modified on the "End Device Parameters" page.

**Update:** After checking/unchecking the boxes, make sure this is clicked to save the changes.

**Readings:** This will take you to the "Readings" page.

**Chart:** This will take you to the "Chart" page.

#### 4.3.9.1 End Device Parameters

**Device Name:** Name of this End Device, this is a text field and can take up to 16 alphanumeric characters.

### 4.3.9.1 End Device Parameters (continued)

END DEVICE PARAMETERS

Address

## END DEVICE PARAMETERS

### End Device 1

Device Name:

Update:  Sec

#### Sensor1

Remote Display Format:

Remote End Char(Hex): 0x

Offset(xxxx):  C

Display:  Alarm

#### Sensor2

Remote Display Format:

Remote End Char(Hex): 0x

Offset(xxxx):  C

[Main Menu](#)

Figure 4.23 End Device Parameters

### 4.3.9.1 End Device Parameters (continued)

**Update (Seconds):** How often this End Device is sending its data to the Meter. The default shown "update second" is 120 seconds. This update corresponds to the sampling rate configured by using the Configuration Wizard. For detailed steps on how to configure the sampling rate, please refer to **Section 4.1 of the UWTC Manual**. Non zero update rate will enable success calculation and lost detection features. Update rate should reflect the actual blinking interval in order to enhance the accuracy of success calculation and lost detection.

**Note** Update on the webpage means how often the Meter expects a reading coming from a End Device. The Meter uses this Update to detect lost condition and calculate success rate. It is purely used by the Meter only, and the End Device does not recognize the Update on the webpage. Therefore, changing Update will not change the actual sample rate stored on the End Device.

**Note** For a more accurate success rate and lost packet information, it is necessary to keep the "Update" time, the same as the "Sampling Rate" of the UWTC End Device.

#### Sensor 1

This is the field to modify the parameters for the process sensor.

**Remote Display Format:** Remote display format is for Server Type *continuous* mode. It basically defines the way the data is shown on a Remote Display. The default value is 0000000F. This means that the value will be displayed up to 7 digits, followed by the unit of F, for a maximum of 8 characters. Any letters before and/or after the number will be displayed accordingly. Keep in mind that the displayed letters will take away from the available 8 characters.

**Note** Make sure that you have enough 0's to display the entire temperature value. Any extra 0's will be ignored. If there is no temperature unit, then the unit will be read from the "Input" menu of the Controller Setup.

**Remote End Char:** The default value is 0D (Hex representation of <CR>). This means that the Meter sends <CR> after each temperature reading. This will be done either in *Continuous* or *Command* mode.

This is how the data will appear on the host with 0D assigned:

T75F  
T74F

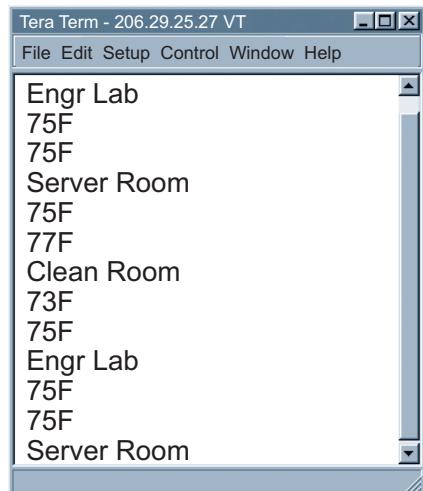

**Figure 4.24**  
**Remote Display**

### 4.3.9.1 End Device Parameters (continued)

If the end character for instance is 20 (Hex representation of space), the data will then appear as: **T75F T74F**

If nothing is set for the "Remote End Char" field, the Meter will then forward the data to the LAN with no characters followed.

**Offset:** If it's determined that the readings are slightly off, the user can manually assign numerical values to adjust the readings for temperature. The unit must be in degree C.

**Display:** To enable or disable numerical display on the Meter's Front Panel. By default, the box is checked (enabled).

**Alarm:** To enable or disable alarms for that particular sensor. By default, the box is checked (enabled).

#### Sensor 2

This is the field to modify the parameters for the ambient sensor.

**Update:** Saves changes.

**Cancel:** Ignores all the changes and goes back to the "End Device Setup" page.

**Reset Device:** Reset the End Device's readings and status. Its data will be cleared immediately.

### 4.3.10 Access Control

This section describes the "Access Control" page of the Wireless System Web interface. This page allows the users to set up the network and security parameters of the Wireless System.

At the initial entrance to the "Access Control" page you may be prompted for the LOGIN Password (see **Figure 4.6**) prior to an ADMINISTRATOR Password.

The screenshot shows a web browser window titled "ACCESS CONTROL" with the address bar displaying "http://192.168.1.200". The main content area features the heading "ACCESS CONTROL" in large, bold, black letters. Below the heading are several input fields with their current values: Login Password (12345678), Admin Password (00000000), Host Name (wis21d9), MAC Address (00:03:03:00:21:D9), IP Address (192.168.1.200), Gateway Address (0.0.0.0), and Subnet Mask (255.255.255.0). Below these fields are two buttons: "Save" and "Reset". Further down is a "Network Reset" button. At the bottom of the form area is a blue link labeled "Main Menu". The browser's status bar at the bottom shows a globe icon and a small progress indicator.

**Figure 4.25 Access Control**

### 4.3.10 Access Control (continued)

**Login Password:** This allows users to access and modify all of the Wireless System Home Page menu items, except "Access Control", which requires an Administrator password. The default Login password is **12345678**. This password can be up to 16 alpha-numeric case-sensitive characters. If there is no Login Password assigned (blank box) the Wireless System will not require a password to access and modify any of the menu items, except the "Access Control" page.

**Admin (administrator) Password:** This allows users to access and modify the "Access Control" page. The default password is **00000000**. This password can be up to 16 alpha-numeric case-sensitive characters.

If there is no Administrator Password assigned (blank box) the Wireless System will not require password to access and modify "Access Control" page.

**Host Name:** Name of the server (DNS) max 8 characters, default is "**wis**" and the last 4 digits of the MAC address. Refer to **Section 3.4**, DNS.

**MAC Address:** This is also called Hardware address or Ethernet address, which is assigned to the Meter at production. The MAC (Media Access Control) address is the Meter's unique hardware number and is not changeable.

**IP Address:** The IP (Internet Protocol) address is a 32-bit number that identifies each sender or Meter of information that is sent in packets across the Ethernet or the Internet. The Meter's default IP address is **192.168.1.200**. The Meter's IP address should be changed to fit user's networking environment. Consult with your IT department for obtaining an IP address.

The DHCP will be enabled in the Meter if its IP address is set to 0.0.0.0. The DHCP can also be enabled by setting the 4 position DIP switch **#3** to **ON**.

**Gateway Address:** A gateway is a network point that acts as an entrance to another network. A gateway is often associated with a router, which knows where to direct a given packet of data that arrives at the gateway. If the Meter is sending packets to another network node that is not on the same network on which the Meter is connected, a gateway address needs to be given to the Meter. The gateway address should be the IP address of the router connected to the same LAN to which the Meter is connected. The Meter default gateway address is **0.0.0.0**. Consult with your IT department for obtaining a gateway address.

**Subnet Mask:** It's a 32-bit number that is used to determine which part of the IP address is the network portion and which part is the host portion. The Meter default subnet mask is **255.255.255.0**. Consult with your IT department for obtaining a subnet mask.

**Save:** Saves any changes for above settings.

**Reset:** Pressing the Reset button will set all the fields back to their original values.

**Network Reset:** Reboots the embedded server. Note that all updated network parameters take effect after reboot.

 **Note**

Changes made in the Access Control page can be saved permanently by pressing the **Save** button and pressing the **Network Reset** button).

## 4.4 Telnet Setup

In the "Network Setup" page, under the Terminal Server section, set the TCP Connections to 1 to 5 other than 0, and use a telnet emulation program to connect to the Meter (using Port 2000). The command can be sent to query the Meter and get a response back.

**Table 4.1 List of ASCII / Telnet Commands (01 indicates End Device #1)**

Command	Description	Response
*SR01a\r	Reading from Sensor1 (process)	66F
*SR01b\r	Reading from Sensor2 (ambient)	68F
*SR01e\r	Readings from Sensor1 and Sensor2	66F 68F
*SR01f\r	Sequence number (0-255)	90
*SR01g\r	Sensor type	230
*SR01h\r	Signal strength (0-100%)	49
*SR01i\r	Success rate (0-100%)	100
*SR01j\r	Battery voltage (mV)	2810
*SR01k\r	Device status (hex, msb on the left hand side) 12th bit: set to enable alarm control 8th bit: set to enable display 7th bit: set when Open detected 6th bit: set when Lost detected	1100
*SR01l\r	Expected sample rate in seconds (also known as update time)	120
*SR01n\r	Name	Conf Room
*SR01o\r	Readings from Sensor1 in Celsius	19
*SR01p\r	Readings from Sensor2 in Celsius	20
*SR00z\r	Display all information	1 230 P66 F A68 F 90 49 100 2810 1100 120 Conf Room 2 230 P69 F A69 F 80 44 100 2810 1100 120 Engr Lab 6 230 P72 F A73 F 173 75 100 3110 1100 120 Server Room 7 230 P70 F A72 F 202 72 100 3450 1100 120 Clean Room

## 4.5 HTTPget Program

The Httpget software is used to send a single HTTP or TCP request to the Meter. In contrast, the telnet or Hyperterminal programs allow a continuous connection with multiple requests to be sent to the Meter.

Generally HTTPget is used for simply programming an IP address to the Meter or for quickly obtaining a reading from a End Device.

The Meter must be configured from the "Network Setup" page so that the "TCP Connections" indicates any number between 1 and 5. Make sure that the Port Field number indicates 2000.

Whenever Terminal Server service (using Port 2000 by default) is required, the # of connections must be set to a value from 1 to 5. The Terminal Server mode is the recommended mode for the most reliable connection when operating with NEWPORT software or with other programs supporting TCP/IP communications.

The Port 2000 access can be used with NEWPORT software and may be needed with some Meters when you need to view readings from the web page while simultaneously collecting data through TCP/IP communications.

### 4.5.1 HTTPget using Port 2000

You can setup and read the information from the Meter by using the HTTPget program. The following program can be used to read data from the embedded server firmware by using TCP port **2000**. The command string is sent to this TCP port, then the response can be read back from the same socket.

The HTTPget.exe file is used to setup and read information from the Meter. This file will be automatically installed when you install the MailNotifier software available on our website and CD.

Notes on using **HTTPget** :

The Httpget.exe program is installed to the windows directory (usually c:\winnt or c:\windows) when installing the Mail Notifier software.

- 1). Open up a command window (or have a DOS window)
  - a) Click on start menu
  - b) Click on "Run"
  - c) In the dialog box that appears, type "cmd" or "command" and click on "OK" button.
  - d) A command window should now appear.
- 2). If you now type "httpget" and press the "enter", the program options should be displayed.
- 3). Next run HTTPget with the options displayed below

```
httpget -r -S *SR00z 192.168.1.135:2000 -C1 -q
```



where:

-r -S are parameters needed for the the command string

**Command** (See Table 4.1)

**192.168.1.135** is an IP address

**2000** is a socket port number

-C1 closes the TCP connection after 1 second

-q displays no error messages once the connection is closed

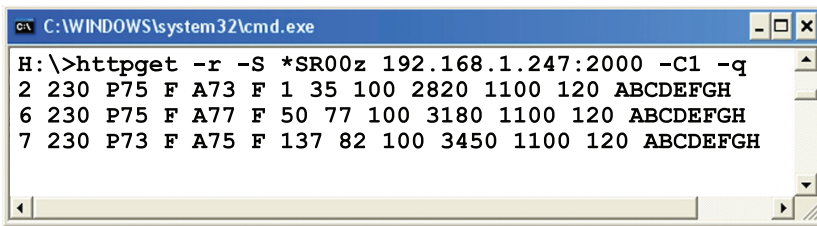

```
C:\WINDOWS\system32\cmd.exe
H:\>httpget -r -S *SR00z 192.168.1.247:2000 -C1 -q
2 230 P75 F A73 F 1 35 100 2820 1100 120 ABCDEFGH
6 230 P75 F A77 F 50 77 100 3180 1100 120 ABCDEFGH
7 230 P73 F A75 F 137 82 100 3450 1100 120 ABCDEFGH
```

Figure 4.26 HTTPget Example of Polling End Device #2,6,7

Table 4.2 Connector/Transmitter Types

UWTC B Type TC	<b>221</b>	UWTC K Type TC	<b>230</b>
UWTC C Type TC	<b>222</b>	UWTC N Type TC	<b>233</b>
UWTC E Type TC	<b>224</b>	UWRTD	<b>235</b>
UWIR	<b>228</b>	UWTC R Type TC	<b>237</b>
UWTC J Type TC	<b>229</b>	UWTC S Type TC	<b>238</b>
		UWTC T Type TC	<b>239</b>

## 4.5.2 HTTPget and ARP to Setup Device IP Address

 Use the iConnect software, which may be downloaded from our website, to do these IP changes whenever possible.

Use ARP first to assign the mac address to a static IP address in computer arp table by this command:

**arp -s 192.168.1.200 00-03-34-00-06-b6**

Then use the following command to assign new IP to the device:

**Httpget -r -S "00000000" 192.168.1.200:1**

where:

"00000000" is admin. password. If the password is wrong, the unit will ignore the new IP. If the new IP is taken, you will get the message "New IP is Assigned" after the HTTPget command. The device will reset automatically.

"192.168.1.200" is an example of an IP address. It is replaced with IP address suitable for your network

"00-03-34-00-06-b6" is replaced with your Meter's MAC address.

## 4.6 ARP Protocol

ARP is the Internet layer protocol responsible for matching or obtaining the MAC (hardware) address that corresponds to a particular IP address. The ARP command allows the user to view the current contents of the ARP cache of the local computer (residing on the same network). Microsoft includes the ARP.EXE utility for viewing and modifying the ARP cache with its Windows products. The following ARP commands can be used to view cache entries:

- **arp -a** → Use this command to view all ARP cache entries.
- **arp -a** plus **IP address** → Use this command to view ARP cache entries associated with one particular interface on a network with multiple adapters.
- **arp -g** → Same as arp -a.
- **arp -N** → Use this command to display ARP entries for specific network interface.
- **arp -s** plus **IP address** plus **Physical address** → Use this command to manually add a permanent static entry to the ARP cache.
- **arp -d** plus **IP address** → Use this command to manually delete a static entry.

The following window shows examples of arp commands and responses.

- Your computer has an IP address of **192.168.1.118**
- The destination computer has an IP address of **192.168.1.96**

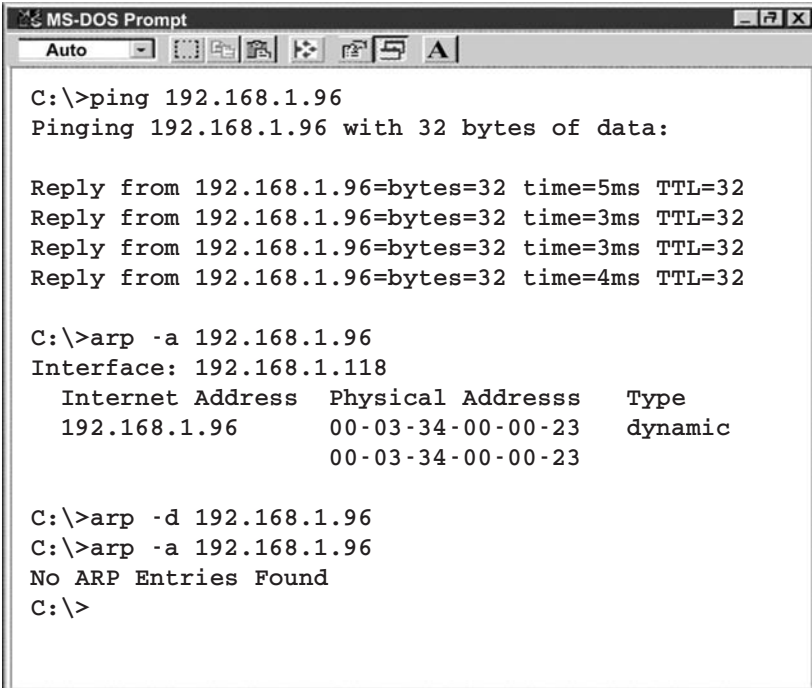

```
MS-DOS Prompt
Auto
C:\>ping 192.168.1.96
Pinging 192.168.1.96 with 32 bytes of data:

Reply from 192.168.1.96=bytes=32 time=5ms TTL=32
Reply from 192.168.1.96=bytes=32 time=3ms TTL=32
Reply from 192.168.1.96=bytes=32 time=3ms TTL=32
Reply from 192.168.1.96=bytes=32 time=4ms TTL=32

C:\>arp -a 192.168.1.96
Interface: 192.168.1.118
    Internet Address    Physical Address    Type
    192.168.1.96        00-03-34-00-00-23  dynamic
                        00-03-34-00-00-23

C:\>arp -d 192.168.1.96
C:\>arp -a 192.168.1.96
No ARP Entries Found
C:\>
```

Figure 4.27 ARP Commands and Responses

## 4.7 iLog Software

This is an Excel application software that can log temperature from the Meter over the local network (Ethernet) or the internet.

- Download the iLog software from the website listed in this manual.
- Install iLog software on a networked PC. This software is compatible with Windows 95, 98, NT, 2000, and XP.
- For complete information of how to use the iLog software, click on the HELP button.
- There is a list of Error Messages in **Appendix E**.

1	Start logging		Stop logging		Options		Clear sheet	
2		Row	56.00		Dev Count	5.00		
3	192.168.1.148	Start Date	6/25/2008		Last Sample	6/25/2008 11:08:46 AM		
4	Time	Dev2/F	Dev2/F	Dev6/F	Dev6/F	Dev7/F	Dev7/F	Error
27	6/25/2008 11:01:42 AM	70.00	68.00	75.00	72.00	91.00	75.00	0
28	6/25/2008 11:01:57 AM	70.00	68.00	73.00	72.00	91.00	75.00	0
29	6/25/2008 11:02:12 AM	70.00	68.00	73.00	72.00	93.00	75.00	0
30	6/25/2008 11:02:27 AM	70.00	68.00	73.00	72.00	93.00	77.00	0
31	6/25/2008 11:02:43 AM	70.00	68.00	77.00	72.00	93.00	77.00	0
32	6/25/2008 11:02:58 AM	70.00	68.00	79.00	72.00	93.00	77.00	0
33	6/25/2008 11:03:13 AM	70.00	68.00	79.00	72.00	93.00	77.00	0
34	6/25/2008 11:03:28 AM	70.00	68.00	79.00	72.00	91.00	77.00	0
35	6/25/2008 11:03:43 AM	68.00	68.00	77.00	73.00	88.00	77.00	0
36	6/25/2008 11:03:58 AM	68.00	68.00	77.00	73.00	84.00	77.00	0
37	6/25/2008 11:04:13 AM	68.00	68.00	75.00	73.00	82.00	77.00	0
38	6/25/2008 11:04:28 AM	68.00	68.00	75.00	73.00	81.00	77.00	0
39	6/25/2008 11:04:43 AM	70.00	68.00	75.00	73.00	79.00	77.00	0
40	6/25/2008 11:04:58 AM	70.00	68.00	75.00	75.00	79.00	77.00	0
41	6/25/2008 11:05:13 AM	70.00	68.00	75.00	75.00	79.00	77.00	0
42	6/25/2008 11:05:29 AM	70.00	68.00	75.00	75.00	79.00	77.00	0
43	6/25/2008 11:05:44 AM	70.00	68.00	75.00	75.00	79.00	77.00	0
44	6/25/2008 11:05:59 AM	70.00	68.00	73.00	75.00	79.00	77.00	0
45	6/25/2008 11:06:14 AM	70.00	68.00	73.00	75.00	79.00	77.00	0
46	6/25/2008 11:06:30 AM	70.00	68.00	73.00	75.00	77.00	77.00	0
47	6/25/2008 11:06:45 AM	70.00	68.00	73.00	75.00	77.00	77.00	0
48	6/25/2008 11:07:00 AM	70.00	68.00	73.00	75.00	77.00	77.00	0
49	6/25/2008 11:07:15 AM	68.00	68.00	73.00	75.00	77.00	77.00	0
50	6/25/2008 11:07:30 AM	68.00	68.00	73.00	75.00	77.00	77.00	0
51	6/25/2008 11:07:45 AM	68.00	68.00	73.00	75.00	77.00	77.00	0
52	6/25/2008 11:08:00 AM	66.00	68.00	73.00	75.00	75.00	77.00	0
53	6/25/2008 11:08:16 AM	66.00	68.00	72.00	75.00	75.00	77.00	0
54	6/25/2008 11:08:31 AM	66.00	68.00	72.00	75.00	75.00	77.00	0
55	6/25/2008 11:08:46 AM	66.00	68.00	72.00	75.00	75.00	77.00	0

Figure 4.28 iLog Software Logging Data for End Device #2, 6, 7

## iLog Software (continued)

**Table 4.3 iLog Excel Applications**

The iLog application actually consists of several Excel files, though most supported devices can be accessed by the main iLog program. The main program is listed as "iLog", plus a version number, under the Start Menu program links (those links available by clicking the Start button on the Windows taskbar).

In the following table, the iLog File column shows how many sensors are logged by the main iLog file. If more than 3 sensors are available, then the Alternate column shows how many sensors the device can support. Devices with more than 3 sensors will have their own Excel file. For these files, click on the model device found in the Start Menu.

<b>Networked Product</b>	<b>iLog File</b>	<b>Alternate</b>
iTHX-W	3 column	
iTHX-M	3 column	
iTHX-W Dual Probe	1st probe / 3 column	6 column
iSE-TC	3 column	5 column
iSE-TH	3 column	5 column
iBTHX-W	3 column	4 column
iBTX	2 column	
iPTX-W	2 column	
iTCX	3 column	
iTH Controller	3 column	
iVI	3 column	4 column
iSeries	1 column	
iDRX/iDRN	1 column	
INF-B	1 column	

### Wireless Devices

The "Auto" column shows number of columns per remote device that are possibly displayed.

The Full column shows number of columns allocated per device for the "Full" spreadsheet, which will be able to display all data for all active devices.

<b>Networked Product</b>	<b>Auto</b>	<b>Full</b>
zSeries Receiver and Remotes	1 to 4 column / device	4 column / 32 device
wiSeries with zED Remotes	1 to 2 column / device	2 column / 32 device
UWTC REC-3 and Remotes	1 or 2 column / device	2 column / 32 device
wiSeries with UWTC Remotes	1 to 2 column / device	2 column / 32 device

The active wireless devices, when shown in the Excel application, will be shown with the device number and the units returned.

## 4.8 Mail Notifier Software

For complete information of how to use the Mail Notifier software, click on the Help menu of the main window.

The Mail Notifier software generates email notifications for alarm conditions. Users can be notified automatically of alarm conditions monitored via internet connections throughout the world. By use of the email forwarding of alarm conditions, alarm conditions can be monitored on a network isolated from the internet and forwarded to connections on the Internet.

The Mail Notifier utility operates under Windows 98, NT 4.0, 2000, and XP in conjunction with existing email that supports the MAPI messaging interface. If MS Outlook™ has been loaded, the MAPI support should be available.

### 4.8.1 Installation

The Mail Notifier must be loaded on a computer running Microsoft™ Windows (versions specified earlier) using an email program that provides MAPI access. Network access must be available between this computer and the Meter. Network access must also be available from this computer to the appropriate email server and from the email server to the recipient's email server.

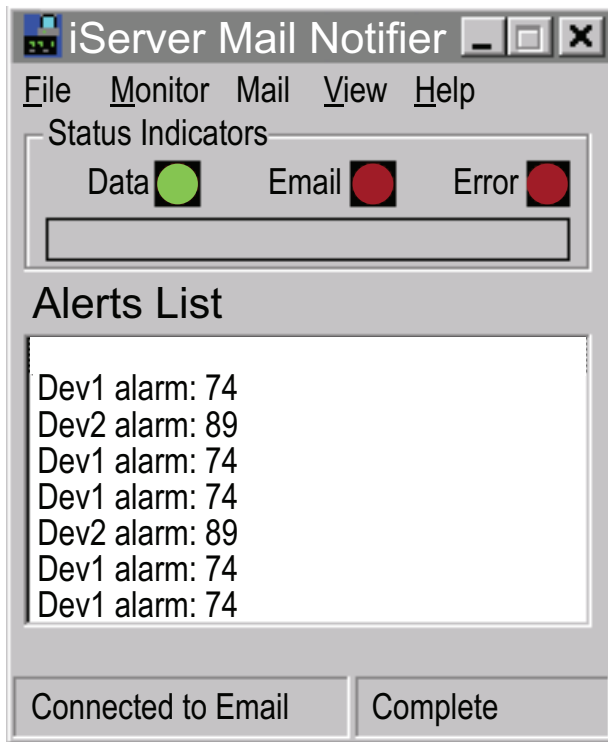

**Figure 4.29 Mail Notifier Main Window**

## 4.8.2 Program Options Setup and Configuration

Complete program setup requires:

- Entering a recipient for the email
- Specifying connection details to MAPI services.
- Defining alarms for devices, and selecting how and when the email will be active.



**Figure 4.30 Mail Notifier Profile Setup**

### Email Address Setup

The email addresses must be entered using individual addresses or alias. Select "Options" from the "View" menu and enter the email addresses on the "Send To" screen. This will be the list of email addresses to which alarm notifications will be sent.

### Email Setup

The Mail Notifier is compatible with original MS Outlook™ and Outlook™ 2002 to 2005. The Mail Notifier will attempt to automatically identify whether the Outlook is a newer version. A red bar appears under the Mail Notifier splash window to confirm that the detection of the 2002 or newer version is acceptable. With the newer versions, no additional steps should be taken to enable the connection between the Mail Notifier and the Email server.



MS Outlook tends to require that the users respond to a "login box" in order for email access to be activated for Mail Notifier. Some other email clients may allow for Mail Notifier to gain access without user login, as may be desired for a system recovering from a power outage. See the Help files for more information.

### 4.8.3 Device Setting and Configuration

The Meter and End Devices should first be configured and ready to use.

Make sure to have the following settings in the "Network" web page of the Meter (**Figure 4.20**) .

Number of Connections = **5**

Port = **2000** (other values may be acceptable as long as Mail Notifier is setup with the same Port number)

Then on the Mail Notifier Alarm Editor, set the BusAddress/DeviceID to match the Device ID number for an End Device and set the Reading Cmd to a Command String from the following table:

**Table 4.4 Mail Notifier Commands**

Desired Value to Monitor	Reading Command String	Actual Command String (see Note 2)
Temperature1 (Process) in scale configured at Meter	SR##a	*SR05a\r
Temperature1 (Process) in Degree C	SR##o	*SR05o\r
Temperature2 (Ambient at End Device sensor) in scale configured at Meter	SR##b	*SR05b\r
Temperature2 (Ambient at End Device sensor) in Degree C	SR##p	*SR05p\r
Battery voltage (mV)	SR##j	*SR05j\r
Signal Level	SR##h	*SR05h\r
Success Rate	SR##i	*SR05i\r



1. The commands used in Mail Notifier are symbolic commands rather than actual Meter commands described in **Table 4.1**.
2. The sample commands in the table above are shown for a sensor with Device ID of 5 such that SR##a, for example, is sent as \*SR05a\r.

### 4.8.3 Device Setting and Configuration (continued)

The screenshot shows a dialog box titled "Alarm Editor" with a close button (X) in the top right corner. The dialog is divided into two main sections: "Device Info (1 of 2)" and "Alarm Configuration".

**Device Info (1 of 2)**

Server IP Address	192.168.1.200
Socket Number	2000
Bus Address/Device ID	5
Description	
Src ID	Dev1
Reading Cmd	SR##a

On the right side of the Device Info section, there are four buttons: "OK", "Cancel", "Help", and "Add". Below these buttons is a checkbox labeled "Only Monitor Access to iServer device", which is currently unchecked.

**Alarm Configuration**

Alarm Type	Alarm High	Info Message	
Alarm High	73	Email Interval	0.05 hrs.
Alarm Low	0	Monitor Interval	0.5 min.
		Alarm Hold Time	0.0 min.

**Figure 4.31 Mail Notifier Device Setting**



## Part 5

### ENVIRONMENT / OPERATING CONDITIONS

The End Device and Meter are designed to be fixed mounted and operated in a clean and dry environment. Care should be taken to prevent the components of your wireless system from being exposed to moisture, toxic chemicals, extreme cold or hot temperature that are outside the specification listed in this manual.

The following is a list of basic good practice you should apply when operating this Wireless System.

1. Do not operate the wireless meter in flammable or explosive environments.
2. Do not use the wireless meter in medical, nuclear or other critical application where failure can cause damage or harm.
3. Always operate the wireless meter within the recommended environmental limits specified in the manual.
4. Do not operate the wireless meter with a battery or AC adapter other than what's supplied or specified in this manual or on the battery compartment label.
5. Keep each wireless meter at least 8 inches (20 cm) from other radio transmitters, antennas, and people.
6. The FCC approval for this meter specifies the specific antenna supplied with this meter.

#### 5.1 General Deployment Guidelines

1. Position Meter in a central location. When multiple End Devices are in operation, position your Meter in a central space if possible in equal distance to each End Device.
2. Test your system before permanent mounting. Try to move the devices to different location around and mounting angles to determine what installation achieves the best signal strength before permanently mounting the End Device.
3. Move your system components higher off the floor and away from exterior walls. The closer the End Device and Meter are, the greater the interference and lose of signal strength will be.
4. Maintain a line-of-sight between antennas and keep Fresnel zone free of obstruction. See **Figure 5.2**.
5. Maintain a constant ambient temperature environment. Exposing your system components to extreme cold or hot temperatures, or sudden changes in ambient conditions will have an effect on the performance of your system.
6. As a general rule in buildings, head height or above is preferred. On the other hand, an End Device which stays close to the floor may have its range reduced by 50% to 90%.

7. Where possible, try to ensure an uninterrupted line-of-sight between nodes. Avoid obscuring objects (e.g. metal pillars, posts, sign) near the antenna. A close object obscures a wider range of solid angle.
8. It is important to understand that the environment may change over time due to new equipment or machinery being installed, building construction, etc. If new obstacles exist between the End Device and Meter, antenna angle may need to be re-adjusted and/or the unit has to be relocated.
9. An IEEE 802.15.4 wireless network will not work under water. Wet condition (e.g. in heavy rainfall) may exhibit some degradation. In most cases, water droplets on or close to the antenna are more serious than the rain itself. Humidity can affect radio performance as well.
10. Reduced performance scenario:
  - a. A large building may have few obstructions between nodes but large amount of metallic paneling that cause reflections.
  - b. A small domestic installation may have numerous brick walls between nodes in individual rooms.
  - c. An office building may have metalized dry-wall partitions together with mezzanine ceilings.

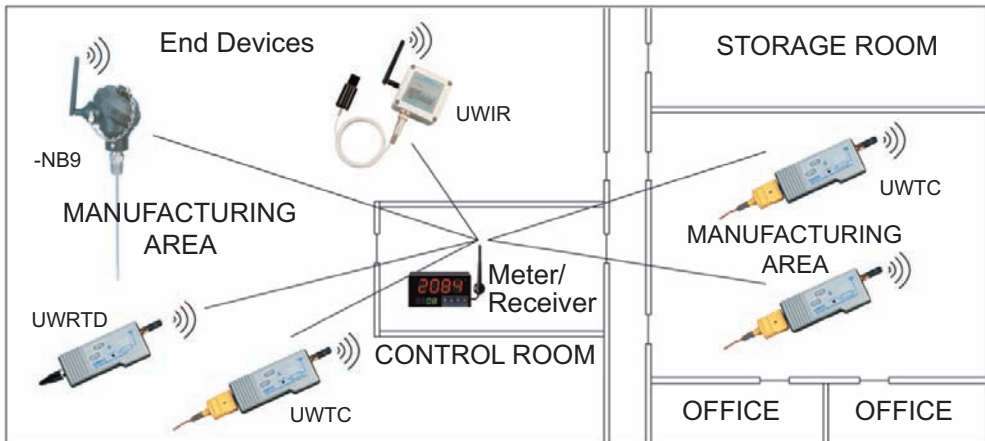

**Figure 5.1 Operation in Buildings**

**Note**

Data is sent through radio signal at 2.4 GHz. Radio signals are electromagnetic waves, hence the signal becomes weaker the further it travels.

While radio waves can penetrate some solid materials like a wall, they can diminish more than when a direct line-of-sight between the transmitting and receiving antenna exist.

Therefore, it is generally a good idea to place Meter at the center while End Devices are located about the same distance away from it. If possible, keeping clearance around the line of site will improve performance as well.

## 5.2 With Line-of-Sight

When installing the Meter it is important to position your device in such a way to optimize the antenna location within what's known as the "Fresnel Zone".

The Fresnel Zone can be thought of as a football-shaped invisible tunnel between two locations that provides a path for RF signals between the End Device and the Meter.

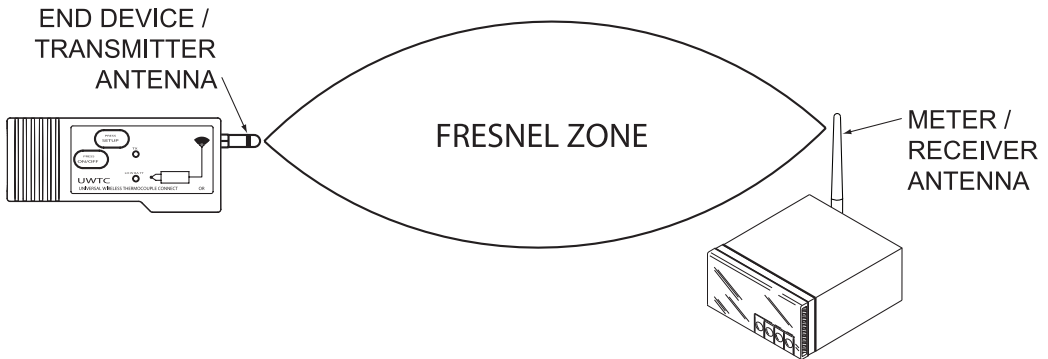

**Figure 5.2 Fresnel Zone**

In order to achieve maximum range, the football-shaped path in which radio waves travel must be free of obstructions. Obstacles in the path (especially metal) will decrease the communication range between the End Device and Meter.

Also, if the antennas are mounted just barely off the ground or below the ceiling, over half of the Fresnel zone ends up being obstructed resulting in significant reduction in range.

Below is the calculated radius of the football-shaped tunnel for different distance range:

Distance (feet)	Radius (feet)
100	3.2
200	4.5
300	5.5

It is recommended that within the tunnel of the above radius, at least 60% of space is free of obstruction.

Since signal reaches destination directly in a line-of-sight situation, it is important to adjust the antenna properly to achieve maximum performance. Antenna for the Meter and End Device should be perpendicular to the plane where the Meter and End Device is located.

### 5.3 Without Line-of-Sight

When line-of-sight is not possible, signal penetrates and is reflected by different objects to reach the destination. Therefore, it is important to learn about how these materials would affect signal propagation.

Depending on the thickness, moisture content and angle of incidence, a wall may allow between 1% and 25% of the radio power to pass through.

Metal panel or metalized glass window will not allow much radio power to pass through. Signal will be reflected if the panel is a mirror.

Some radio power may propagate through small holes in the panel or around metal edges through the process of diffraction.

<b>Material Type</b>	<b>Possible Signal Reduction</b>
Wood, Plaster, Sheetrock, Fiberglass Uncoated Glass w/out Metal	0 to 10%
Brick, Pressboard	5 to 35%
Reinforced Concrete	10 to 90%
Metal Walls, Metal Doors, Elevators, Metal Piping, Metal Stair Cases, Metal Mesh, Metal Screening	90 to 100%

**Figure 5.3 Materials in Buildings**

In a non-line-of-sight situation at 2.45 GHz, it is possible to move the receive antenna only 1 to 1 1/2" (3 to 4 cm) and see signal strength varies from 6 dB to -20 dB due to multiple signal reflection path. Therefore, there should be about 20 dB path loss margin to take signal fading into account.

### 5.4 Casing and Closure Around the Antenna

See **Section 2.1.4.2** and **Figure 2.5**.

## **PART 6**

### **SPECIFICATIONS**

#### **ON/OFF CONTROL OUTPUT 1 & 2**

<b>Relay:</b>	250 Vac or 30 Vdc @ 3 A (Resistive Load), SPDT
<b>Solid State Relay (SSR):</b>	20 to 265 Vac @ 0.05 to 0.5 A (Resistive Load); continuous
<b>DC Pulse:</b>	Non-Isolated; 10 Vdc @ 20 mA
<b>Analog Output (Output 1 only)</b>	Non-Isolated, 0 to 10 Vdc or 0 to 20 mA, 500 $\Omega$ max
<b>Operation:</b>	Direct (cool), reverse (heat); deadband; single sensing input
<b>Configuration</b>	Output 1 and 2 can be configured as Alarm 1 and 2, respectively. Analog Output for Output 1 can be configured as retransmission.

#### **ALARM 1 & 2 (PROGRAMMABLE)**

<b>Type:</b>	SPDT Relay, SSR, and DC Pulse
<b>Operation:</b>	High/low, above/below, band, latch/unlatch, normally open/normally closed and process/deviation; front panel configurations; single/multiple sensing input(s)

#### **ANALOG RETRANSMISSION OUTPUT (PROGRAMMABLE)**

<b>Type:</b>	Non-Isolated, Retransmission 0 to 10 Vdc or 0 to 20 mA, 500 $\Omega$ max (Output 1 only).
<b>Operation:</b>	Single sensing input; accuracy is $\pm 1\%$ of FS when following conditions are satisfied: 1) Input is not scaled below 1% of Input FS. 2) Analog Output is not scaled below 3% of Output FS.

#### **INSULATION**

<b>Power to Output:</b>	2300 Vac per 1 min. test 1500 Vac per 1 min. test (Low Voltage/Power Option)
<b>Power to Relays/SSR Outputs:</b>	2300 Vac per 1 min. test
<b>Relays/SSR to Relay/SSR Outputs:</b>	2300 Vac per 1 min. test

#### **GENERAL**

<b>Display:</b>	4-digit, 9-segment LED, 10.2mm (0.40") and 21mm (0.83") red, green and amber programmable colors
<b>Digital Filter:</b>	Programmable

## GENERAL

<b>Connection:</b>	Screw terminals
<b>Line Voltage/Power:</b>	90 to 240 Vac +/-10%, 50 to 400 Hz*; 110 to 375 Vdc, equivalent voltage; 5 W <i>* No CE compliance above 60 Hz</i>
<b>Low Voltage/Power Option:</b>	20 to 36 Vdc or 24 Vac** +/-10%; 4 W External power source must meet Safety Agency Approvals. <i>** Units can be powered safely with 24 Vac power but, no Certification for CE are claimed.</i>
<b>External Fuse Required:</b>	
<b>Time-Lag, IEC 127-3 recognized:</b>	100 mA/250 V 400 mA/250 V (Low Voltage/Power Option)
<b>Time-Delay, UL 248-14 listed:</b>	100 mA/250 V 400 mA/250 V (Low Voltage/Power Option)
<b>Environmental Conditions:</b>	0 to 50°C (32 to 122°F), 90% RH non-condensing
<b>Protection:</b>	NEMA-1/Type 1 front bezel
<b>Dimensions:</b>	48H x 96W x 127mm D (1.89 x 3.78 x 5")
<b>Panel Cutout:</b>	45H x 92mm W (1.772 x 3.622")
<b>Weight:</b>	353 g (0.78 lb)
<b>Software:</b>	The software packages available for the Temperature Wireless System products are <b>iConnect</b> (configuration software for the Ethernet interface), <b>iLog</b> (Excel-based software for automatic data logging), and <b>Mail Notifier</b> (email alarm notification software).

## INTERFACE SPECIFICATIONS

<b>Ethernet:</b>	Standards Compliance IEEE 802.3 10Base-T (RJ45)
<b>Supported Protocols:</b>	TCP, UDP, ARP, ICMP, DHCP, DNS, HTTP, and Telnet
<b>LED Indicators:</b>	Network Activity, Network Link, Diagnostics, Receive & Power
<b>Management:</b>	Device configuration and monitoring through embedded Web Server
<b>Embedded Web Server:</b>	Serves WEB pages (Java™ Applets) containing real-time data and live updated charts within definable time intervals.

## WIRELESS COMMUNICATION

<b>Standard:</b>	DSSS; IEEE 802.15.4
<b>Frequency</b>	2.4 GHz (2410 MHz), Channel #12
<b>Network Topology:</b>	Star Topology

## WIRELESS COMMUNICATION (continued)

**Radio Power Output:** 100 mW (20 dBm), 10 mW (10 dBm)

**Note**

Limitations on Equivalent Isotropic Radiated Power (EIRP) levels in the European Community and other countries applies. An improper combination of power level can result in an EIRP above the allowed amount per regulations. See **Appendix F**.

**Data Rate:** Bit rate 250 Kp/s; Symbol rate 62.5 Symbol/s; Chip rate 2000 kchip/s

**Modulation:** Orthogonal Quaternary Phase Shift Keying (O-QPSK)

**Meter/Receiver Sensitivity:** -100 dBm

**Range:** The range depends on the specific Connector/Transmitter used. Refer to the **UWTC Manual** for more specifications.

**Note**

The range assume a Line-of-Sight (LOS) between the Meter/Receiver and Connector/Transmitter without obstructions or interference at which the diagnostic signal strength web interface registers approximately 25%.

**Antenna Frequency:** 2400 to 2500 Mhz

**Impedance:** 50 ohm

**Connector:** Reverse Polarity SMA Plug

## SAFETY & REGULATORY COMPLIANCE

**Safety:** EN 61010-1:2001  
Safety requirements article 3.1.a of the R&TTE

**EMC:** EN 301 489-1 V1.6.1:2005-09  
Electromagnetic compatibility article 3.1.b of the R&TTE  
EN 301 489-17 V1.2.1:2002-08  
Electromagnetic compatibility article 3.1.b of the R&TTE  
EN 55022:2006 + A1:2007, Class A, (CISPR 22 +A1:2005)

**Radio:** EN 300 328 V1.7.1:2006-10 Spectrum article 3(2) of the R&TTE

**FCC:** Part 15C, Class DTS Intentional radiator tested for 15.205, 15.209, 15.247(d), 15.215(c), 15.247(a)(2), 15.247(b), 15.247(e).  
See **Appendix F**.

This device complies with part 15 of the FCC Rules. Operation is subject to the following two conditions: (1) This device may not cause harmful interference, and (2) this device must accept any interference received, including interference that may cause undesired operation.

**CE:** The product herewith complies with the essential requirements and other relevant provisions of the R&TTE Directive 1999/5/EC, the EMC Directive 2004/108/EC, and the Low Voltage Directive 2006/95/EC, and carries the CE-marking accordingly.

The following CE Mark  is affixed to this equipment.

See **Appendix F**. The CE declaration is available at the website listed on the cover page of this manual.

## PART 7 FACTORY PRESET VALUES

To set the Wireless and Ethernet settings back to Factory Default do the following to the DIP switches (see **Figure 2.11**).

To set the Ethernet board to Factory Default settings:

- 1) Put the 4 position DIP switch **#2** to **ON** position (it does not matter if the Meter is On or Off).
- 2) Power-cycle the Meter and wait about 10 seconds until the Meter fully boots up.
- 3) Put the DIP switch **#2** back to **OFF** position (it does not matter if the Meter is powered On or Off, just make sure that the DIP switch is set to **OFF**, otherwise, everytime the unit is power-cycled the factory settings will take over).

To set the Wireless board to Factory Default settings:

- 1) Put the 8 position DIP switch **#1** to **ON** position (it does not matter if the Meter is On or Off).
- 2) Power-cycle the Meter and wait about 10 seconds until the Meter fully boots up.
- 3) Put the DIP switch **#1** back to **OFF** position (it does not matter if the Meter is powered On or Off, just make sure that the DIP switch is set to **OFF**, otherwise, everytime the unit is power-cycled the factory settings will take over).



The defaults that will change are noted by a "**W**" or "**E**" in the Table below. The defaults for the Meter/Controller "**C**" are set by the individual Setup menus.

- C** = Meter/Controller Board
- W** = Wireless or Coordinator Board
- E** = Ethernet or iServer Board

**Table 7.1 Factory Preset Values**

CONTROLLER SETUP			
Input			
Control End Device ID	1		<b>W</b>
Filter	4		<b>C</b>
Temperature Unit	F		<b>C</b>



**Table 7.1 Factory Preset Values (continued)**

<b>Setpoints &amp; On/Off Control</b>		
Auto Setpoint Deviation	Disabled	<b>C</b>
Setpoint 1	0	<b>C</b>
Setpoint 2	100	<b>C</b>
Permanent Store	<input checked="" type="checkbox"/>	<b>C</b>
On/Off 1	Disabled	<b>C</b>
Deadband	10	<b>C</b>
Action	Reverse	<b>C</b>
On/Off 2	Disabled	<b>C</b>
Deadband	10	<b>C</b>
Action	Reverse	<b>C</b>
<b>Alarm 1</b>		
Alarm 1 Relay	Enabled	<b>C</b>
Alarm 1 Low	-100	<b>C</b>
Alarm 1 high	4000	<b>C</b>
Active	Above	<b>C</b>
Normally	Open	<b>C</b>
Latch	Unlatched	<b>C</b>
Absolute	Absolute	<b>C</b>
Alarm at Power On	Enabled	<b>C</b>
<b>Alarm 2</b>		
Alarm 2 Relay	Enabled	<b>C</b>
Alarm 2 Low	-100	<b>C</b>
Alarm 2 high	4000	<b>C</b>
Active	Hi/Lo	<b>C</b>
Normally	Open	<b>C</b>
Latch	Unlatched	<b>C</b>
Absolute	Absolute	<b>C</b>
Alarm at Power On	Enabled	<b>C</b>
<b>Display</b>		
Screen Update (secs)	3	<b>W</b>
Normal	Green	<b>C</b>
Alarm 1	Red	<b>C</b>
Alarm 2	Amber	<b>C</b>
<b>Passcode ID</b>		
Setpoint ID	Disabled	<b>C</b>
Full ID	Disabled	<b>C</b>
ID	0000	<b>C</b>

**Table 7.1 Factory Preset Values (continued)**

<b>Analog Output Retransmission</b>		
Retransmission	Enabled	<b>C</b>
Voltage/Current	Voltage	<b>C</b>
Input Low	0	<b>C</b>
Output Low	0.00	<b>C</b>
Input High	1000	<b>C</b>
Output High	10.00	<b>C</b>
<b>Monitor</b>		
Scrolling	<input checked="" type="checkbox"/>	<b>W</b>
End Device ID	-	-
Permanent Store	<input type="checkbox"/>	<b>W</b>
<b>Transmission Power</b>		
Channel 12	-	-
Transmission Power	20 dBm	<b>W</b>
<b>Misc</b>		
PID 13106 (version x.x)	-	-
iSeries Firmware Ver x.x	-	-
<b>NETWORK SETUP</b>		
<b>General</b>		
Secured Applet	<input type="checkbox"/>	<b>E</b>
Title	wiSeries	<b>E</b>
<b>Terminal Server</b>		
TCP/IP	TCP	<b>E</b>
Server Type	Command	<b>E</b>
Forward CR	Enable	<b>E</b>
Number of Connections	1	<b>E</b>
Port	02000	<b>E</b>
<b>Remote Access (Tunneling)</b>		
Remote IP Address	0.0.0.0	<b>E</b>
Remote Port	02000	<b>E</b>
Remote Access	Disable	<b>E</b>
<b>Access Control</b>		
Login Password	12345678	<b>E</b>
Admin Password	00000000	<b>E</b>
Host name	wisxxxx	-
MAC Address: 00:03:34:00:xx:xx		-
IP Address	192.168.1.200	<b>E</b>
Gateway Address	0.0.0.0	<b>E</b>
Subnet Mask	255.255.255.0	<b>E</b>

**Table 7.1 Factory Preset Values (continued)**

End Device Setup								
-	E	W	E	C	E	E	W	W
ID	Name	Update	Network	Units	Remote Format	End Char	Display	Alarm
<u>1</u>	ABCDEFGH	120	<input checked="" type="checkbox"/>	F	0000000F	0D	<input checked="" type="checkbox"/>	<input checked="" type="checkbox"/>
			<input checked="" type="checkbox"/>	F	0000000F	0D		
<u>2</u>	ABCDEFGH	120	<input checked="" type="checkbox"/>	F	0000000F	0D	<input checked="" type="checkbox"/>	<input checked="" type="checkbox"/>
			<input checked="" type="checkbox"/>	F	0000000F	0D		
<u>3</u>	ABCDEFGH	120	<input checked="" type="checkbox"/>	F	0000000F	0D	<input checked="" type="checkbox"/>	<input checked="" type="checkbox"/>
			<input checked="" type="checkbox"/>	F	0000000F	0D		
<u>4</u>	ABCDEFGH	120	<input checked="" type="checkbox"/>	F	0000000F	0D	<input checked="" type="checkbox"/>	<input checked="" type="checkbox"/>
			<input checked="" type="checkbox"/>	F	0000000F	0D		
<u>5</u>	ABCDEFGH	120	<input checked="" type="checkbox"/>	F	0000000F	0D	<input checked="" type="checkbox"/>	<input checked="" type="checkbox"/>
			<input checked="" type="checkbox"/>	F	0000000F	0D		
<u>6</u>	ABCDEFGH	120	<input checked="" type="checkbox"/>	F	0000000F	0D	<input checked="" type="checkbox"/>	<input checked="" type="checkbox"/>
			<input checked="" type="checkbox"/>	F	0000000F	0D		
<u>7</u>	ABCDEFGH	120	<input checked="" type="checkbox"/>	F	0000000F	0D	<input checked="" type="checkbox"/>	<input checked="" type="checkbox"/>
			<input checked="" type="checkbox"/>	F	0000000F	0D		
<u>8</u>	ABCDEFGH	120	<input checked="" type="checkbox"/>	F	0000000F	0D	<input checked="" type="checkbox"/>	<input checked="" type="checkbox"/>
			<input checked="" type="checkbox"/>	F	0000000F	0D		

END DEVICE PARAMETERS		
End Device # (1 - 8)		
Device Name	ABCDEFGH	<b>E</b>
Update	120 secs	<b>W</b>
<b>Sensor 1</b>		
Remote Display Format	0000000F	<b>E</b>
Remote End Char(Hex) 0x	0D	<b>E</b>
Offset (xxxx)	0	<b>W</b>
Display	<input checked="" type="checkbox"/>	<b>W</b>
Alarm	<input checked="" type="checkbox"/>	<b>W</b>
<b>Sensor 2</b>		
Remote Display Format	0000000F	<b>E</b>
Remote End Char(Hex) 0x	0D	<b>E</b>
Offset (xxxx)	0	<b>W</b>

User of this manual should be familiar with following definitions:

**ARP (Address Resolution Protocol)** is a protocol for mapping an Internet Protocol address (IP address) to a physical machine address that is recognized in the local network. For example, the IP address in use today is an address that is 32-bits long. In an Ethernet local area network, however, addresses for attached devices are 48-bits long. (The physical machine address is also known as a Media Access Control or MAC address.) A table, usually called the ARP cache, is used to maintain a correlation between each MAC address and its corresponding IP address. ARP provides the protocol rules for making this correlation and providing address conversion in both directions.

**Ethernet** is a network protocol defined by the IEEE 802.3 standard. Ethernet-based networks use MAC Address rather than IP Address to exchange data between computers. By using ARP and adding TCP/IP support, Ethernet devices may be connected as part of the Internet. An Ethernet LAN typically uses coaxial cable or special grades of twisted pair wires. The most commonly installed Ethernet systems are called 10BASE-T and provide transmission speeds up to 10 Mbps. Devices are connected to the cable and compete for access using a Carrier Sense Multiple Access with Collision Detection (CSMA/CD) protocol.

**IP (Internet Protocol)** is the method or protocol by which data is sent from one computer to another on the Internet.

**IP address (Internet Protocol address)** is a 32-bit number that identifies each sender or receiver of information that is sent in packets across the Internet.

**IP Netmask** is a 32-bit pattern of bits used to determine which part of the IP address is the network portion and which part is the host portion.

**MAC (Media Access Control) Address** is your computer's unique hardware number. When you're connected to the Internet from your computer, a correspondence table relates your IP address to your computer's physical (MAC) address on the LAN.

**Ping** is a utility that tests the network connectivity. It is used to determine if the host is capable of exchanging information with another host.

**Port number/Socket number** is a way to identify a specific process to which an Internet or other network message is to be forwarded when it arrives at a server. It is a predefined address that serves as a route from the application to the Transport layer or from the Transport layer to the application of the TCP/IP system.

**Sockets** are a method for communication between a client program and a server program in a network and defined as "the endpoint in a connection." Information transferred across the Internet primarily occurs between sockets.

**TCP/IP (Transmission Control Protocol/Internet Protocol)** is the basic communication language or protocol of the Internet. When you are set up with direct access to the Internet, your computer is provided with a copy of the TCP/IP program just as every other computer that you may send messages to or get information from also has a copy of TCP/IP. TCP/IP often is used as a general term to indicate generic access to the Internet.

**UDP/IP (User Datagram Protocol/Internet Protocol)** is the TCP/IP standard protocol that allows an application program on one machine to send a datagram to an application program on another. The UDP can be either in Broadcast or Directed form. The Broadcast UDP transmits data to every node on the same network. The Directed UDP transmits data to one node only.

## Appendix B

## IP Address

An IP address is a unique 32-bit address assigned to a computer and includes:

- A network ID number identifying a network.
- A host ID number identifying a computer on the network.

All IP addresses have been divided into three smaller groups (classes) A, B and C

- **Class A** addresses have 8-bits of network ID and 24-bits of host ID. They can support a large number of hosts, approximately  $2^{24} = 16,777,216$  computers per network.

The IP addresses range in binary from 00000001.xxxxxxxx.xxxxxxxx.xxxxxxxx  
to 01111111.xxxxxxxx.xxxxxxxx.xxxxxxxx

The IP addresses range in decimal from 1.x.x.x to 127.x.x.x

Class A network ID's support a very large number of hosts.

- **Class B** addresses have 16-bits of network ID and 16-bits of host ID. They can support approximately  $2^{16} = 65,536$  computers per network.

The IP addresses range in binary from 10000000 00000000.xxxxxxxx.xxxxxxxx  
to 10111111 11111111.xxxxxxxx.xxxxxxxx

The IP addresses range in decimal from 128.0.x.x TO 191.255.xxx.xxx

Class B network ID's support a medium number of hosts.

- **Class C** addresses have 24-bits of network ID and 8-bits of host ID. They can support approximately  $2^8 = 256$  computers per network.

The IP addresses range in binary from 11000000.00000000.00000000.xxxxxxxx  
to 11011111.11111111.11111111.xxxxxxxx

The IP addresses range in decimal from 192.0.0.xxx to 223.255.255.xxx

Class C network ID's support a small number of hosts.

**Note**

The rest of the addresses are divided into two classes, D and E.

**Class D networks** are not assigned to the host. They are used for multicasting.  
The address range from 224.x.x.x to 239.x.x.x

**Class E** networks are experimental or reserved addresses.

The address range from 240.x.x.x to 247.x.x.x

## Appendix C

## IP Netmask

IP Netmask or Subnet Mask is a 32-bit pattern of ones and zeros used to determine network portion of an IP address from the host portion of the IP address. Subnet mask is a network ID that is created by borrowing bits from host portion of IP address and using them as part of a network ID. The table below shows a default subnet mask for address Classes A, B, and C. Each bit that is set to "1" in the subnet mask corresponds to the bit in the IP address that is to be used as the network ID. Each bit that is set to "0" in the subnet mask corresponds to a bit in the IP address that is to be used as the host ID.

Address Class	Mask Binary Value	Mask Decimal Value or Dotted Notation
Class A	11111111 00000000 00000000 00000000	255.0.0.0
Class B	11111111 11111111 00000000 00000000	255.255.0.0
Class C	11111111 11111111 11111111 00000000	255.255.255.0

If your network requires more network ID's, you can extend the default subnet mask to include additional bits from the host ID. This allows for additional network ID's within the network. The table below shows some examples of subnet masks and bits moved from the hosts ID to create a new subnet.

Mask Dotted Notation	Mask Binary	Mask Bits
<b>Class A</b>		
255.0.0.0 (Default)	11111111 00000000 00000000 00000000	0
255.192.0.0	11111111 11000000 00000000 00000000	2
255.224.0.0	11111111 11100000 00000000 00000000	3
255.240.0.0	11111111 11110000 00000000 00000000	4
255.248.0.0	11111111 11111000 00000000 00000000	5
255.252.0.0	11111111 11111100 00000000 00000000	6
255.254.0.0	11111111 11111110 00000000 00000000	7
255.255.0.0	11111111 11111111 00000000 00000000	8
255.255.128.0	11111111 11111111 10000000 00000000	9
255.255.192.0.0	11111111 11111111 11000000 00000000	10
.....	.....	.
255.255.255.252	11111111 11111111 11111111 11111100	22
<b>Class B</b>		
255.255.0.0 (Default)	11111111 11111111 00000000 00000000	0
255.255.192.0	11111111 11111111 11000000 00000000	2
.....	.....	.
255.255.255.252	11111111 11111111 11111111 11111100	14
<b>Class C</b>		
255.255.255.0 (Default)	11111111 11111111 11111111 00000000	0
255.255.255.192	11111111 11111111 11111111 11000000	2
.....	.....	.
255.255.255.254	11111111 11111111 11111111 11111100	6

To determine the number of valid hosts ID's remaining after subnetting, use the following equation:  $2^n - 2$ , where n is the number of octet digits left after the subnet mask.

## Appendix D

## ASCII Chart

ASCII Char	Dec	Hex	Binary No Parity	ASCII Char	Dec	Hex	Binary No parity
NUL	00	00	00000000	@	64	40	01000000
SOH	01	01	00000001	A	65	41	01000000
STX	02	02	00000010	B	66	42	01000010
ETX	03	03	00000011	C	67	43	01000011
EOT	04	04	00000100	D	68	44	01000100
ENQ	05	05	00000101	E	69	45	01000101
ACK	06	06	00000110	F	70	46	01000110
BEL	07	07	00000111	G	71	47	01000111
BS	08	08	00001000	H	72	48	01001000
HT	09	09	00001001	I	73	49	01001001
LF	10	0A	00001010	J	74	4A	01001010
VT	11	0B	00001011	K	75	4B	01001011
FF	12	0C	00001100	L	76	4C	01001100
CR	13	0D	00001101	M	77	4D	01001101
SO	14	0E	00001110	N	78	4E	01001110
SI	15	0F	00001111	O	79	4F	01001111
DLE	16	10	00010000	P	80	50	01010000
DC1	17	11	00010001	Q	81	51	01010001
DC2	18	12	00010010	R	82	52	01010010
DC3	19	13	00010011	S	83	53	01010011
DC4	20	14	00010100	T	84	54	01010100
NAK	21	15	00010101	U	85	55	01010101
SYN	22	16	00010110	V	86	56	01010110
ETB	23	17	00010111	W	87	57	01010111
CAN	24	18	00011000	X	88	58	01011000
EM	25	19	00011001	Y	89	59	01011001
SUB	26	1A	00011010	Z	90	5A	01011010
ESC	27	1B	00011011	[	91	5B	01011011
FS	28	1C	00011100	\	92	5C	01011100
GS	29	1D	00011101	]	93	5D	01011101
RS	30	1E	00011110	^	94	5E	01011110
US	31	1F	00011111	_	95	5F	01011111
SP	32	20	00100000	`	96	60	01100000
!	33	21	00100001	a	97	61	01100001
"	34	22	00100010	b	98	62	01100010
#	35	23	00100011	c	99	63	01100011
\$	36	24	00100100	d	100	64	01100100
%	37	25	00100101	e	101	65	01100101
&	38	26	00100110	f	102	66	01100110
'	39	27	00100111	g	103	67	01100111
(	40	28	00101000	h	104	68	01101000
)	41	29	00101001	i	105	69	01101001
*	42	2A	00101010	j	106	6A	01101010
+	43	2B	00101011	k	107	6B	01101011
,	44	2C	00101100	l	108	6C	01101100
-	45	2D	00101101	m	109	6D	01101101
.	46	2E	00101110	n	110	6E	01101110

**Appendix D****ASCII Chart Continuation**

/	47	2F	00101111	o	111	6F	01101111
0	48	30	00110000	p	112	70	01110000
1	49	31	00110001	q	113	71	01110001
2	50	32	00110010	r	114	72	01110010
3	51	33	00110011	s	115	73	01110011
4	52	34	00110100	t	116	74	01110100
5	53	35	00110101	u	117	75	01110101
6	54	36	00110110	v	118	76	01110110
7	55	37	00110111	w	119	77	01110111
8	56	38	00111000	x	120	78	01111000
9	57	39	00111001	y	121	79	01111001
:	58	3A	00111010	z	122	7A	01111010
;	59	3B	00111011	{	123	7B	01111011
<	60	3C	00111100		124	7C	01111100
=	61	3D	00111101	}	125	7D	01111101
>	62	3E	00111110	~	126	7E	01111110
?	63	3F	00111111	DEL	127	7F	01111111

**ASCII Control Codes**

ASCII Char	Dec	Hex	Ctrl Key Equiv.	Definition	ASCII Char	Dec	Hex	Ctrl Key Equiv.	Definition
NUL	00	00	Ctrl @	Null Character	DC1	17	11	Ctrl Q	Data Control 1 - XON
SOH	01	01	Ctrl A	Start of Header	DC2	18	12	Ctrl R	Data Control 2
STX	02	02	Ctrl B	Start of Text	DC3	19	13	Ctrl S	Data Control 3 - XOFF
ETX	03	03	Ctrl C	End of Text	DC4	20	14	Ctrl T	Data Control 4
EOT	04	04	Ctrl D	End of Transmission	NAK	21	15	Ctrl U	Negative Acknowledge
ENQ	05	05	Ctrl E	Inquiry	SYN	22	16	Ctrl V	Synchronous Idle
ACK	06	06	Ctrl F	Acknowledge	ETB	23	17	Ctrl W	End of Trans Block
BEL	07	07	Ctrl G	Bell	CAN	24	18	Ctrl X	Cancel
BS	08	08	Ctrl H	Back Space	EM	25	19	Ctrl Y	End of Medium
HT	09	09	Ctrl I	Horizontal Tabulation	SUB	26	1A	Ctrl Z	Substitute
LF	10	0A	Ctrl J	Line Feed	ESC	27	1B	Ctrl [	Escape
VT	11	0B	Ctrl K	Vertical Tabulation	FS	28	1C	Ctrl \	File Separator
FF	12	0C	Ctrl L	Form Feed	GS	29	1D	Ctrl ]	Group Separator
CR	13	0D	Ctrl M	Carriage Return	RS	30	1E	Ctrl	Record Separator
SO	14	0E	Ctrl N	Shift Out	US	31	1F	Ctrl _	Unit Separator
SI	15	0F	Ctrl O	Shift In	SP	32	20		Space
DLE	16	10	Ctrl P	Data Link Escape					



## Appendix E

## iLog Error Messages

Error #	Description	Note
-8003	User stopped logging readings.	
-10005	Failed to find the Meter.	Ethernet cable is disconnected, iServer is powered off, connections across the firewall require longer "connection to socket time out" setting.
-10006	Windows socket was closed.	
-10007	Windows socket error.	Wrong IP or wrong Port number was used.
-10008	The Meter failed to respond to a request.	Wrong IP or wrong Port number was used.
-10011	Response came empty.	No data was sent.
-10012	Device responded with "Serial Time Out" string.	Possibly the iLog is configured for wrong product model.
-10014	Terminal Server Mode when the Port is 1000.	Try Port 2000 in iLog configuration.
-15100	Error on obtaining the temperature reading.	Possibly the iLog is configured for wrong product model.

## Appendix F Warnings and Regulatory Information



In order to comply with FCC radio frequencies (RF) exposure limits, dipole antennas should be located at a minimum 7.9" (200mm) or more from the body of all persons.

This device complies with part 15 rules. Operation is subject to the following two conditions:

- 1) this device may not cause harmful interference, and
- 2) this device must accept any interference received, including interference that may cause undesired operation.

This equipment has been tested and found to comply with the limits of a Class B digital device, pursuant to Part 15 of the FCC Rules. These limits are designed to provide reasonable protection against harmful interference when the equipment is operated in a residential environment. This equipment generates, uses, and radiates radio frequency energy, and if not installed and used in accordance with the instructions, may cause harmful interference. However, there is no guarantee that interference will not occur. If this equipment does cause interference to radio or television reception, which can be determined by turning the equipment off and on, the user is encouraged to correct the interference by one of the following measures:

- Reorient or relocate the receiving antenna.
- Increase separation between the equipment and receiver.
- Connect the equipment to an outlet on a circuit different from which the receiver is connected.
- Consult dealer or an experienced radio/TV technician.

## Appendix F Warnings and Regulatory Information (continued)



The following alert sign indicates that there are restrictions on usage of the equipment in regards to power limitations on Equivalent Isotropic Radiated Power (EIRP) levels in the European Community.

### The following are user restrictions:

- Wideband Data Transmission Systems on the band 2400 – 2483.5 MHz in Europe is limited to a Maximum of 10 mW (10 dBm) for Direct Sequence Spread Spectrum (DSSS). See Annex 3 of ERC/REC 70-03, decision ERC/DEC/ (01)07.
- Combinations of power levels and antennas resulting in a radiated power level above 10 mW - EIRP for Direct Sequence Spectrum (DSSS) devices are considered as not compliant, and are not allowed for use within the European Community and other countries that have adopted the European R&TTE directive 1995/5/EC or the CEPT recommendation ERC/REC 70-03 or both.
- The users in Europe are instructed to change the default 20 dBm level to 10 dBm via the Web Interface of the Meter/Receiver.

### MAXIMUM POWER LEVELS AND ANTENNA GAINS

	Antenna Gain	Output Max	Maximum Radiated
U.S.A (Regulatory 4W)	2.2 dBi	18.0 dBm	20 dBm
EUROPE (Regulatory 10mW) (DSSS)	2.2 dBi	7.0 - 7.5 dBm	10 dBm

#### Note

The default 20 dBm must be changed to 10 dBm to comply with power level regulations. The 0.5 dBm variation depends on the internal DC power used (3V, 3.3V, 3.7V max) of the different models.



## WARRANTY/DISCLAIMER

OMEGA ENGINEERING, INC. warrants this unit to be free of defects in materials and workmanship for a period of **one (1) year** from the date of purchase. In addition to OMEGA's standard warranty period, OMEGA Engineering will extend the warranty period for **one (1) additional year** if the warranty card enclosed with each instrument is returned to OMEGA.

If the unit malfunctions, it must be returned to the factory for evaluation. OMEGA's Customer Service Department will issue an Authorized Return (AR) number immediately upon phone or written request. Upon examination by OMEGA, if the unit is found to be defective, it will be repaired or replaced at no charge. OMEGA's WARRANTY does not apply to defects resulting from any action of the purchaser, including but not limited to mishandling, improper interfacing, operation outside of design limits, improper repair, or unauthorized modification. This WARRANTY is VOID if the unit shows evidence of having been tampered with or shows evidence of having been damaged as a result of excessive corrosion; or current, heat, moisture or vibration; improper specification; misapplication; misuse or other operating conditions outside of OMEGA's control. Components which wear are not warranted, including but not limited to contact points, fuses, and triacs.

**OMEGA is pleased to offer suggestions on the use of its various products. However, OMEGA neither assumes responsibility for any omissions or errors nor assumes liability for any damages that result from the use of its products in accordance with information provided by OMEGA, either verbal or written. OMEGA warrants only that the parts manufactured by it will be as specified and free of defects. OMEGA MAKES NO OTHER WARRANTIES OR REPRESENTATIONS OF ANY KIND WHATSOEVER, EXPRESS OR IMPLIED, EXCEPT THAT OF TITLE, AND ALL IMPLIED WARRANTIES INCLUDING ANY WARRANTY OF MERCHANTABILITY AND FITNESS FOR A PARTICULAR PURPOSE ARE HEREBY DISCLAIMED. LIMITATION OF LIABILITY: The remedies of purchaser set forth herein are exclusive, and the total liability of OMEGA with respect to this order, whether based on contract, warranty, negligence, indemnification, strict liability or otherwise, shall not exceed the purchase price of the component upon which liability is based. In no event shall OMEGA be liable for consequential, incidental or special damages.**

CONDITIONS: Equipment sold by OMEGA is not intended to be used, nor shall it be used: (1) as a "Basic Component" under 10 CFR 21 (NRC), used in or with any nuclear installation or activity; or (2) in medical applications or used on humans. Should any Product(s) be used in or with any nuclear installation or activity, medical application, used on humans, or misused in any way, OMEGA assumes no responsibility as set forth in our basic WARRANTY/DISCLAIMER language, and, additionally, purchaser will indemnify OMEGA and hold OMEGA harmless from any liability or damage whatsoever arising out of the use of the Product(s) in such a manner.

## RETURN REQUESTS/INQUIRIES

Direct all warranty and repair requests/inquiries to the OMEGA Customer Service Department. BEFORE RETURNING ANY PRODUCT(S) TO OMEGA, PURCHASER MUST OBTAIN AN AUTHORIZED RETURN (AR) NUMBER FROM OMEGA'S CUSTOMER SERVICE DEPARTMENT (IN ORDER TO AVOID PROCESSING DELAYS). The assigned AR number should then be marked on the outside of the return package and on any correspondence.

The purchaser is responsible for shipping charges, freight, insurance and proper packaging to prevent breakage in transit.

FOR WARRANTY RETURNS, please have the following information available BEFORE contacting OMEGA:

1. Purchase Order number under which the product was PURCHASED,
2. Model and serial number of the product under warranty, and
3. Repair instructions and/or specific problems relative to the product.

FOR NON-WARRANTY REPAIRS, consult OMEGA for current repair charges. Have the following information available BEFORE contacting OMEGA:

1. Purchase Order number to cover the COST of the repair,
2. Model and serial number of product, and
3. Repair instructions and/or specific problems relative to the product.

OMEGA's policy is to make running changes, not model changes, whenever an improvement is possible. This affords our customers the latest in technology and engineering.

© Copyright 2009 OMEGA ENGINEERING, INC. All rights reserved. This document may not be copied, photocopied, reproduced, translated, or reduced to any electronic medium or machine-readable form, in whole or in part, without the prior written consent of OMEGA ENGINEERING, INC.

**TRADEMARK NOTICE:**  <sup>®</sup>, *omega.com*<sup>®</sup>,  **OMEGA**<sup>®</sup>, and  are Trademarks of OMEGA ENGINEERING, INC.

**PATENT NOTICE:** This product is covered by one or more of the following patents: U.S. Pat. No. Des. 336,895; 5,274,577/ CANADA 2052599; 2052600 / ITALY 1249456; 1250938 / FRANCE BREVET No. 91 12756 / SPAIN 2039150; 2048066 / UK PATENT No. GB2 249 837; GB2 248 954 / GERMANY DE 41 34398 C2. Other US and International Patents pending or applied for.

# Where Do I Find Everything I Need for Process Measurement and Control? **OMEGA...Of Course!** *Shop on line at [omega.com](http://omega.com)*

## **TEMPERATURE**

- Thermocouple, RTD & Thermistor Probes, Connectors, Panels & Assemblies
- Wire: Thermocouple, RTD & Thermistor
- Calibrators & Ice Point References
- Recorders, Controllers & Process Monitors
- Infrared Pyrometers

## **PRESSURE, STRAIN AND FORCE**

- Transducers & Strain Gauges
- Load Cells & Pressure Gauges
- Displacement Transducers
- Instrumentation & Accessories

## **FLOW/LEVEL**

- Rotameters, Gas Mass Flowmeters & Flow Computers
- Air Velocity Indicators
- Turbine/Paddlewheel Systems
- Totalizers & Batch Controllers

## **pH/CONDUCTIVITY**

- pH Electrodes, Testers & Accessories
- Benchtop/Laboratory Meters
- Controllers, Calibrators, Simulators & Pumps
- Industrial pH & Conductivity Equipment

## **DATA ACQUISITION**

- Data Acquisition & Engineering Software
- Communications-Based Acquisition Systems
- Plug-in Cards for Apple, IBM & Compatibles
- Datalogging Systems
- Recorders, Printers & Plotters

## **HEATERS**

- Heating Cable
- Cartridge & Strip Heaters
- Immersion & Band Heaters
- Flexible Heaters
- Laboratory Heaters

## **ENVIRONMENTAL MONITORING AND CONTROL**

- Metering & Control Instrumentation
- Refractometers
- Pumps & Tubing
- Air, Soil & Water Monitors
- Industrial Water & Wastewater Treatment
- pH, Conductivity & Dissolved Oxygen Instruments